



DPO6000, MPO6000 Series

Digital Fluorescent Oscilloscope

Product Manual

V 1.3

Copyright Statement

Copyright

Qingdao Hantek Electronic Co., Ltd.

Statement

Qingdao Hantek Electronic Co., Ltd. reserves the right to amend this document without prior notice. Qingdao Hantek Electronic Co., Ltd. promises that the information provided is correct and reliable, but does not guarantee that this document is infallible. Please make sure that the specifications of relevant technical documents used are the latest and valid version yourself before using this product. If you require the cooperation of products, patents or works of a third party when your company using the documents or products of Qingdao Hantek Electronic Co., Ltd., your company shall be responsible for obtaining the consent and authorization of the third party. The aforesaid consent and authorization are not the responsibility of our company to guarantee.

Technical Support

If you have any question or ambiguity in the process of using products of Qingdao Hantek Electronic Co., Ltd., you can get the service and support through the following ways:

A: Please contact the local dealer of Qingdao Hantek Electronic Co., Ltd.;

B: Please contact the local office directly under Qingdao Hantek Electronic Co., Ltd.;

C: Please contact the headquarters of Qingdao Hantek Electronic Co., Ltd.

Contact Method of our company:

Qingdao Hantek Electronic Co., Ltd.

<http://www.hantek.com/en/index.html>

Address: 35# Building No.780 Baoyuan Road, High-tech District, Qingdao China

Zip Code: 266114

Telephone: 0532-88705792

Fax: 0532-88705691

Email: service@Hantek.com

Technical Support:

Telephone: 0532-88703687

Email: support@Hantek.com

Summary of general safety matters

General Safety Summary

Read the following safety precautions carefully to avoid injury and prevent damage to this product or any product connected to this product. To avoid possible danger, be sure to use this product as specified.

Avoid fire and personal injury.

Only professionally authorized personnel should perform repairs.

Use the correct power cord.

Use only the power cord specified for this product in your country.

Connect and disconnect properly.

Before connecting the probe to the circuit under test, please connect the probe to the oscilloscope; before disconnecting the probe from the oscilloscope, disconnect the probe from the circuit under test.

Ground the product.

To avoid electric shock, the product is grounded through the grounding conductor of the power cord. The grounding conductor must be connected to ground. Before connecting the input or output of the product, be sure to ground the product properly.

Connect the probe properly.

If using a probe, the probe ground must be connected to the ground. Do not connect the probe ground lead to high voltage, otherwise, dangerous voltage may be generated on the oscilloscope and probe connector, control equipment or other surfaces, which may cause injury to the operator.

View all terminal ratings.

To avoid fire or the impact of excessive current, check all ratings and markings on the product. Please consult the product manual for details on ratings before connecting the product.

Use proper overvoltage protection.

Make sure that no over voltages (such as those caused by lightning) reach the product. Otherwise, the operator may be exposed to electric shock.

Do not open the cover.

Do not operate the product with the cover or panel open.

Maintain proper ventilation.

Poor ventilation will increase the temperature of the instrument and cause damage to the instrument. Good ventilation should be maintained during use, and the vents and fans should be checked regularly.

Use a suitable fuse.

Only use fuses specified for this product.

Avoid exposed circuits.

Do not touch exposed connectors and components after power is turned on.

Do not operate the product if you suspect it is malfunctioning.

If the user suspects that this product has been damaged, have it inspected by qualified service personnel.

Do not operate in a humid environment.

To avoid the danger of short circuit or electric shock inside the instrument, do not operate the instrument in a humid environment.

Do not operate in a flammable or explosive environment.

To avoid damage to the instrument or personal injury, do not operate the instrument in a flammable or explosive environment.

Keep the surface of the product clean and dry.

To prevent dust or moisture in the air from affecting the performance of the instrument, keep the product surface clean and dry.

Anti-static protection.

Static electricity can cause damage to the instrument. Test in an anti-static area whenever possible. Before connecting the cable to the instrument, ground its inner and outer conductors briefly to discharge static electricity.

Pay attention to handling safety.

In order to avoid the instrument falling down during transportation, which may cause damage to the buttons, knobs, or interfaces on the instrument panel, please pay attention to transportation safety.

Safety terms and symbols

Product terminology. The following terms may appear on the product:

DANGER

It indicates that if you do this, you may cause immediate damage to the user.

WARNING

It indicates that the user may not immediately harm the user if they do this.

CAUTION

It indicates that the user may cause damage to this product or other property if this operation is performed.

Product symbol. The following symbols may appear on the product:



Safety Warning



Protective Test



Ground Shell



Earth Terminal

Measurement category

Measurement category DPO6000 / MPO6000 series digital oscilloscopes can perform measurement under measurement category I.



WARNING

This oscilloscope is only allowed to be used in the specified measurement category.

Measurement category definition

Measurement category I

Refers to measurements on circuits that are not directly connected to the mains. For example, make measurements on circuits that are not derived from a main power source, especially those that are protected (internal). In the latter case, the transient stress changes. Therefore, users should understand the instantaneous ability of the device.

Measurement category II

Refers to measurements made on circuits directly connected to low-voltage equipment. For example, make measurements on home appliances, portable tools, and similar devices.

Measurement category III

Refers to measurements in construction equipment. For example, power distribution boards, circuit breakers, wiring (including cables, bus bars, junction boxes, switches, sockets) in fixed equipment, and equipment for industrial use and certain other equipment (for example, fixed motors permanently connected to fixed equipment) Take measurements.

Measurement category IV

Refers to measurement at the source of the low-voltage equipment. Examples are electricity meters, measurements on major overcurrent protection devices, and measurements on pulse control units.

Ventilation requirements

The oscilloscope is forcedly cooled by a fan. Ensure that the intake and exhaust areas are free of obstructions and free-flowing air. To ensure adequate ventilation, when using the oscilloscope in a workbench or rack, ensure that there is a gap of at least 10 cm on its sides, above, and behind.



WARNING

Poor ventilation will increase the temperature of the instrument and cause damage to the instrument. Good ventilation should be maintained during use. Regularly check the vents and fans.

Working environment

Temperature

During operation: 0°C to +50°C

Non-operating: -40°C to +70°C

Humidity

0°C to +30°C: 95% relative humidity

+30°C to +40°C: 75% relative humidity +40°C to +50°C: 45% relative humidity



WARNING

To avoid the danger of short circuit or electric shock inside the instrument, do not operate the instrument in a humid environment.

Altitude

When operating: below 3000 meters

Non-operating: below 15000 meters

Daily maintenance and cleaning

Daily maintenance

When storing or placing the oscilloscope, do not expose the LCD monitor to direct sunlight for a long time.

**CAUTION**

To avoid damaging the oscilloscope or probe, do not place it in mist, liquid or solvent.

Clean

According to the requirements of operating conditions, check the oscilloscope and probe frequently. Please clean the outer surface of the instrument according to the following steps:

Use a lint-free cloth to remove dust from the outside of the oscilloscope and probe. Be careful not to scratch the smooth display filter.

Clean the oscilloscope with a soft cloth dampened with water. For more thorough cleaning, use 75% isopropyl alcohol in water.

**CAUTION**

To avoid damaging the surface of the oscilloscope or probe, do not use any corrosive or chemical cleaning agents.

Equipment recycling

Production of this equipment requires the extraction and use of natural resources. If this product is not disposed of properly, some of the substances contained in the device may be harmful to the environment or human health. To avoid release of harmful substances into the environment and reduce the use of natural resources, it is recommended that this product be recycled by appropriate methods to ensure that most materials can be reused correctly.

Introduction to DPO6000 / MPO6000 Series Digital Phosphor Oscilloscope

DPO6000 / MPO6000 series oscilloscopes have extremely high memory depth, ultra-wide dynamic range, good display effect, and high waveform capture rate and up to 16 trigger functions, 5 serial decoding functions, which are communication, aerospace, national defense, embedded Instrumentation in many industries and fields such as embedded systems, computers, research and education.

Main feature:

★The real-time sampling rate of the analog channel is 1GSa/s, the standard configuration is 64Mpts, and the maximum memory depth is 128Mpts (6000EDU series).

★Digital channel real-time sampling rate 1GSa/s

★200MHz, 100MHz and 80MHz analog channel bandwidths are available

- ★4 analog channels, 16 (4*4) digital channels (MPO6000 series; DPO6000 series can be upgraded to use digital channels by purchasing LP104 digital probe)
- ★Two / three-channel signal source (MPO6000EDU is three channels) Built-in 13 kinds of waveforms, 4 groups of arbitrary waveforms, 200MSa/s sampling rate, 8Kpts waveform length
- ★60,000 wfms/s (point display) / 400,000 wfms/s (point display fast acquisition mode) waveform capture rate
- ★Segmented acquisition function, supports up to 80,000 segments
- ★256-level grayscale display
- ★Ultra-low noise floor, ultra-wide vertical dynamic range from 500uV/div to 10V/div
- ★7-inch WVGA (800*480) TFT widescreen, vivid colors, low power consumption, and long life
- ★7-inch capacitive touch screen, support multi-touch
- ★Adjustable waveform brightness and display brightness
- ★Up to 16 trigger functions, including 5 protocol triggers
- ★Provide 5 kinds of serial decoding options
- ★42 kinds of waveform parameter automatic measurement (statistic function optional)
- ★5-digit digital voltmeter and 6-digit hardware frequency meter function
- ★Bode plot function (optional signal source function)
- ★Event search function
- ★Dual window display function
- ★Built-in FFT function
- ★Multiple waveform mathematical operation function
- ★Standard ports: USB Device, USB Host, LAN
- ★WIFI (6000EDU series)
- ★Optional interface: HDMI, UART, AUX
- ★Pass/fail, trigger output (standard for MPO6000EDU, optional for non-MPO6000EDU)
- ★Meets LXI CORE 2011 DEVICE-type instrument standards, enabling rapid, economical, and efficient creation and reconstruction and reconfiguration of test systems
- ★Support remote command control
- ★Embedded help for easy access to information

★New and exquisite industrial design, convenient operation

Product model list

The MPO6000 / DPO6000 series includes the following models. Unless otherwise specified, this manual uses the MPO6204EDU as an example to explain the functions and operation methods of the oscilloscope.

Model	Channel	Bandwidth	Storage Depth	Sampling Rate	Refresh Rate	Wave Gen	Logic Analyzer	USB/LAN	Touch Screen	WLAN	Pass/Fail
DPO608XB	2/4	80MHz	64M	1GSa/s	60,000/400,000	-	-	Yes	Yes	-	
DPO610XB	2/4	100MHz	64M	1GSa/s	60,000/400,000	-	-	Yes	Yes	-	
DPO620XB	2/4	200MHz	64M	1GSa/s	60,000/400,000	-	-	Yes	Yes	-	
DPO608XC	2/4	80MHz	64M	1GSa/s	60,000/400,000	25MHz*2	-	Yes	Yes	-	
DPO610XC	2/4	100MHz	64M	1GSa/s	60,000/400,000	25MHz*2	-	Yes	Yes	-	
DPO620XC	2/4	200MHz	64M	1GSa/s	60,000/400,000	25MHz*2	-	Yes	Yes	-	
MPO608XD	2/4	80MHz	64M	1GSa/s	60,000/400,000	25MHz*2	4*4 LA	Yes	Yes	-	
MPO610XD	2/4	100MHz	64M	1GSa/s	60,000/400,000	25MHz*2	4*4 LA	Yes	Yes	-	
MPO620XD	2/4	200MHz	64M	1GSa/s	60,000/400,000	25MHz*2	4*4 LA	Yes	Yes	-	
DPO608XEDU	2/4	80MHz	128M	1GSa/s	60,000/400,000	-	-	Yes	Yes	Yes	
DPO610XEDU	2/4	100MHz	128M	1GSa/s	60,000/400,000	-	-	Yes	Yes	Yes	
DPO620XEDU	2/4	200MHz	128M	1GSa/s	60,000/400,000	-	-	Yes	Yes	Yes	
MPO608XEDU	2/4	80MHz	128M	1GSa/s	60,000/400,000	25MHz*3	4*4 LA	Yes	Yes	Yes	Yes
MPO610XEDU	2/4	100MHz	128M	1GSa/s	60,000/400,000	25MHz*3	4*4 LA	Yes	Yes	Yes	Yes
MPO620XEDU	2/4	200MHz	128M	1GSa/s	60,000/400,000	25MHz*3	4*4 LA	Yes	Yes	Yes	Yes

Quick Start

This chapter describes the precautions when using the oscilloscope for the first time, the front and rear panels of the oscilloscope, the user interface, and how to use the built-in help system.

General inspection

Checking the shipping packaging

If you find that the packaging carton or foam protective pad is seriously damaged, please keep it until the whole machine and accessories pass the electrical and mechanical tests.

Check the whole machine

If you find that the appearance of the instrument is damaged, that the instrument is not working properly, or that it fails the performance test, please contact the dealer responsible for this business.

Check random accessories

If you find that the accessory is missing or damaged, please contact the dealer responsible for the business. Details of the attachments provided are described in "Appendix A: Attachments" at the end of this note.

Physical dimension

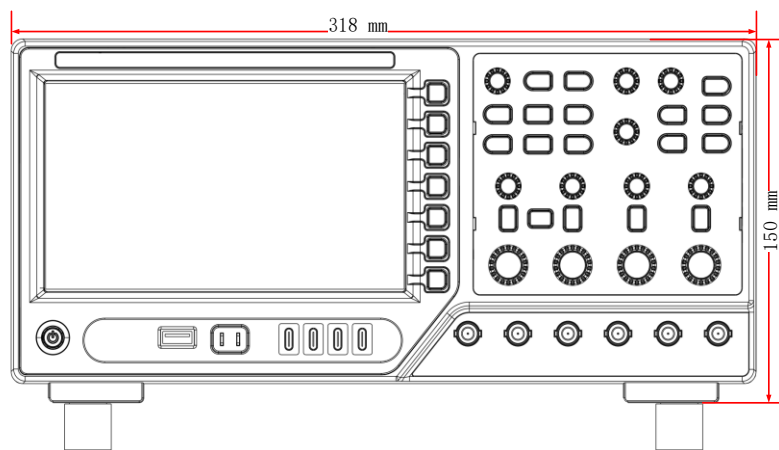

Front view

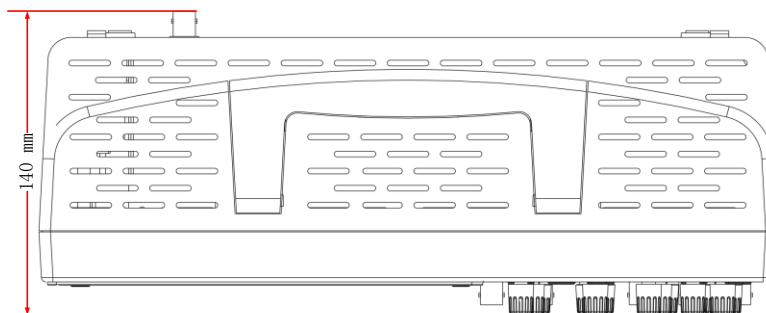

Top view

Ready to use the instrument

Adjusting the bracket

Properly adjust the stand so that it is upright, tilt the oscilloscope upward, and place the oscilloscope stably, so as to better operate and observe the display screen.

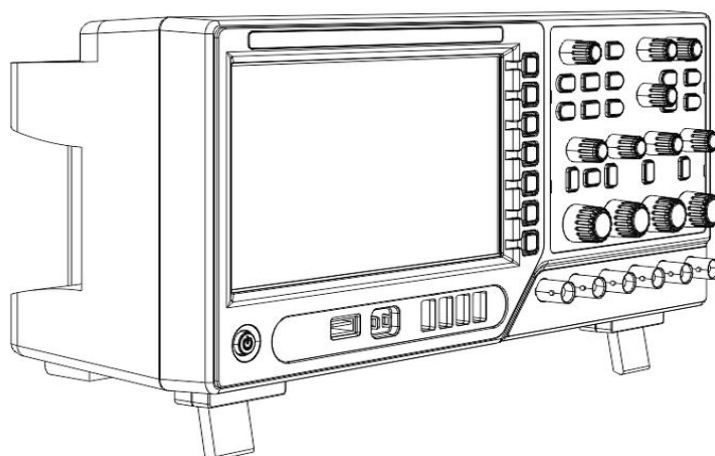

Adjust the support feet

Connect the power cord as required

The specifications of the AC power source that this oscilloscope can input are: 100-120Vac, 50/60/400Hz; 100-240Vac, 50/60Hz; 50W max.

Connect the oscilloscope to an AC power source using the power cord provided in the accessory (shown below).

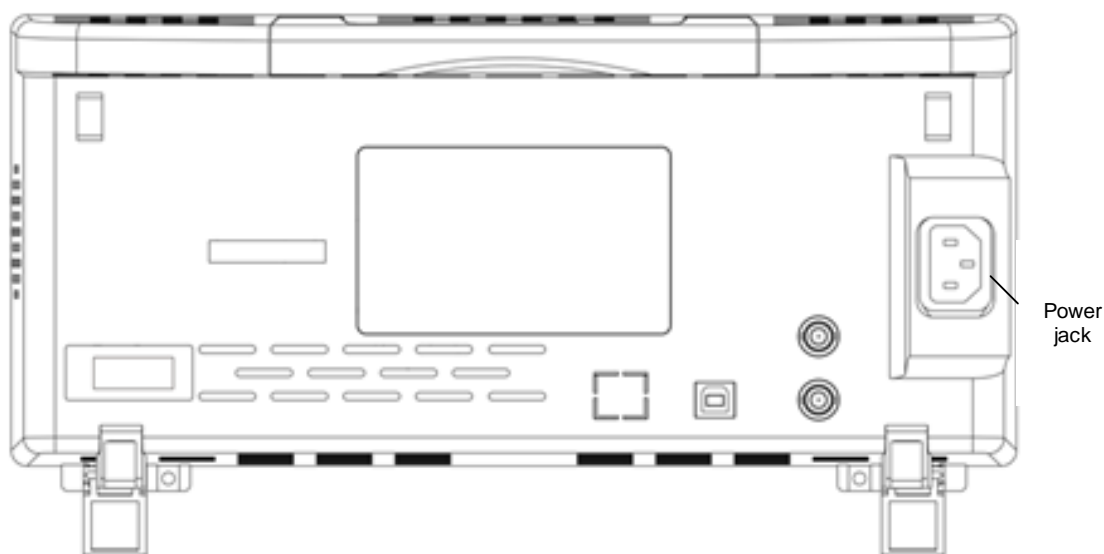

Connect the power supply

Startup check

When the oscilloscope is powered on, press the power switch in the lower left corner of the front panel to start the oscilloscope. During startup, the oscilloscope performs a series of self-tests. During the self-test, the keyboard indicators light up according to a certain sequence of rules. After the self-test ends, the startup screen appears.

Probe inspection

Safety

When using the probe, to avoid electric shock, keep your fingers behind the safety ring on the probe body. Do not touch the metal part on the top of the probe when the probe is connected to a high voltage power supply. Before making any measurements, connect the probe to the oscilloscope and ground the ground terminal.

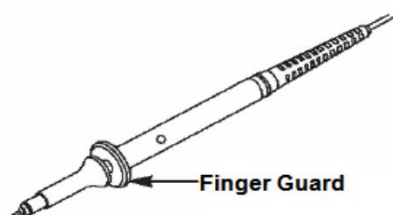

Probe attenuation setting

Probes have different attenuation coefficients, which affect the vertical scale of the signal. The "Probe Check" function verifies that the probe attenuation options match the probe attenuation.

Press the "Vertical Menu" button (such as the [CH1] menu button) to select a probe option that matches the probe attenuation coefficient.

Make sure the "Attenuation" switch on the probe matches the "Probe" option in the oscilloscope, and set the switches to X1, X10.

When the Attenuation switch is set to X1, the probe limits the oscilloscope's bandwidth to 6MHz. When the "Attenuation" switch is set to X10, the oscilloscope has full bandwidth.

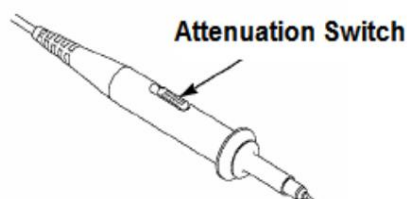

Connect the probe

DPO6000 series oscilloscopes are equipped with passive probes as standard, and MPO6000 series are equipped with passive and digital probes as standard.

Connect the passive probe:

1. Connect the BNC end of the probe to the analog channel input on the front panel of the oscilloscope.

2. Connect the probe ground alligator clip or ground spring to the circuit ground terminal, and then connect the probe to the circuit under test.

Connect the logic probe:

1. Connect one end of the digital probe to the digital channel input interface on the front panel of the oscilloscope (the digital probe has no direction).
2. Connect the other end of the digital probe to the signal under test. The MPO6000 series comes standard with four LP104 digital probes.

Check the probe voltage

Each time you connect a probe to an input channel, you should perform a probe check.

Use the "Vertical Menu" button; for example, press the **CH1** menu button to set the probe attenuation coefficient.

Manual probe compensation

When connecting the probe to any input channel for the first time, make this adjustment to match the probe to the input channel. Uncompensated or compensated probes can cause measurement errors or errors. To adjust the probe compensation, follow these steps:

1. Set the probe option attenuation to 10X in the Channel Menu. Set the switch on the probe to 10X and connect the probe to channel 1 of the oscilloscope. If using the probe hook end, make sure that the hook end is firmly seated on the probe. Connect the probe tip to the probe element: ~ 2V @ 1K Hz connector, and connect the reference wire to the "probe element ground" connector, then press the "Auto Scale" button.

2. Check the shape of the displayed waveform

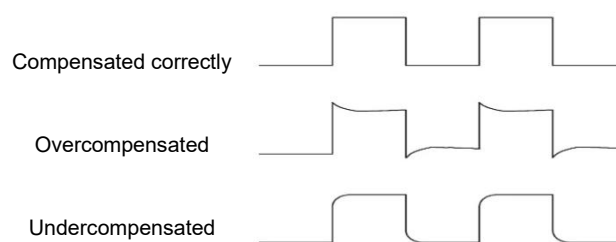

3. If necessary, use a non-metallic screwdriver to adjust the variable capacitance on the probe until the waveform shown on the screen is "compensated correctly" as shown above. Repeat this step if necessary. The adjustment method is shown in the figure below.

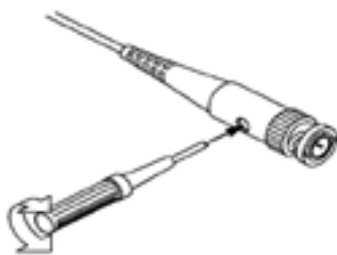

Front panel overview

The following content briefly describes and introduces the front panel part of the 6000 series oscilloscope, so that users can become familiar with the 6000 series digital oscilloscope in the shortest time.

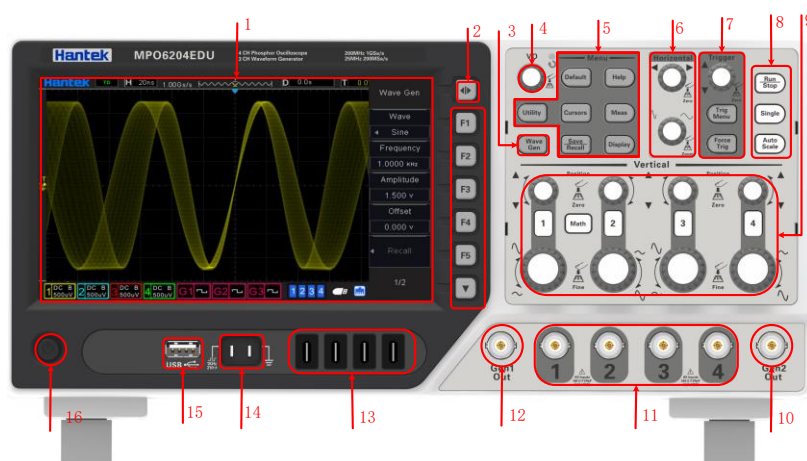

SN	Description	SN	Description
1	LCD	9	Vertical control system
2	Menu show/hide keys	10	Signal source 2 output channel
3	Signal source button (signal source series)	11	CH1~CH4 signal input channel
4	Multifunction knob	12	Signal source 1 output channel
5	Menu function buttons	13	LA1 ~ LA4 signal input channels (MPO6000 series)
6	Level control system	14	Probe compensation signal output/ground
7	Trigger control system	15	USB Host port
8	Shortcuts (Run/Stop, Single, Auto Scale)	16	Power On Key

Rear panel overview

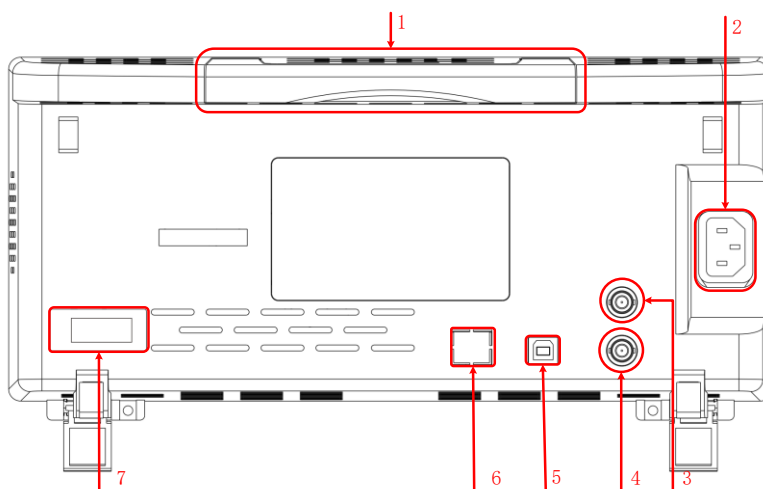

1. Handle

Pull the handle vertically to carry the oscilloscope conveniently. When not needed, just press down on the handle.

2. AC power jack

AC power input. Please use the power cord provided to connect the oscilloscope to AC power, and press the power button on the front panel to turn it on.

3. AUX port trigger output and pass / fail [optional]

Trigger output:

When the oscilloscope generates a trigger, a pulse can be output through this interface. This pulse is the signal of the oscilloscope's current capture rate. Connect this signal to the waveform display device and measure the frequency of the signal. The measurement result is the same as the current capture rate.

Pass / Fail:

In the pass / fail test, when the oscilloscope detects a failure, it will output a pulse through this connector. When no failure is detected, it will continuously output a low level through this connector.

4. Signal source 3 source output [MPO6000EDU Series]

Signal source 3 output is only for the 3-channel signal source built into the oscilloscope. When the oscilloscope signal source 3 is turned on, the signal source port outputs signals according to the current settings.

5. USB Device

This interface allows you to connect the oscilloscope to a computer or a printer. When

connected to a computer, users can send SCPI commands or custom programming to control the oscilloscope through the host computer software. When the printer is connected, the user prints the waveform displayed on the screen through the printer.

6. LAN / UART

LAN

Connect the oscilloscope to the network through this interface to remotely control it. This oscilloscope complies with the LXI CORE 2011 DEVICE class instrument standard and can quickly build a test system.

UART [optional]

This interface connects the oscilloscope to a control system for remote control.

7. HDMI interface [optional]

You can connect the oscilloscope to a monitor with an HDMI display through this interface to get a larger display.

Front panel functions

Introduction of the main keys

Level control system



Horizontal offset:

Modify the horizontal displacement. When the knob is turned, the trigger point moves left and right relative to the center of the screen. During the modification, the waveforms of all channels move left and right, and the horizontal displacement information in the upper right corner of the screen changes in real time.

Press this knob to quickly reset the horizontal displacement.

Horizontal time base:

Modify the horizontal time base. Turn clockwise to decrease the time base and turn counterclockwise to increase the time base. During the modification, the waveforms of all channels are expanded or compressed, and the time base information at the top of the screen changes in real time.

Press this knob to quickly switch between single and double window display modes.

Vertical control system

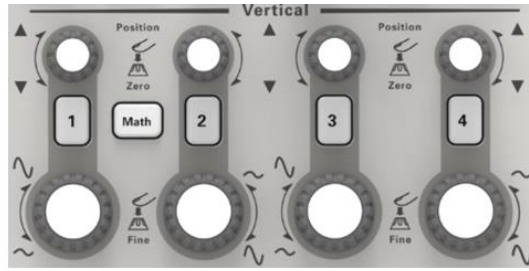



	<p>Analog input channel switch. Press any button to open the corresponding channel menu, and press again to close the channel.</p>
	<p>Math: Press the "Math" button to open the Math setup menu, and press again to close the Math function.</p>
	<p>Vertical offset: Modify the vertical shift of the current channel waveform. Turn clockwise to increase displacement, turn counterclockwise to decrease displacement. During the modification, the waveform will move up and down, and the displacement information displayed at the top right of the screen will change in real time. Press this knob to quickly zero the vertical displacement.</p>
	<p>Vertical voltage: Modify the vertical scale of the current channel. Turn clockwise to decrease gears and turn counterclockwise to increase gears. During the modification, the waveform display amplitude will increase or decrease, and the gear information at the bottom left of the screen will change in real time. Press this knob to quickly switch the vertical scale adjustment mode to "Coarse" or "Fine".</p>

Signal source

	<p>WaveGen: Press this key to enter the setting interface of the signal source. Set the waveform and parameters of the output signal from the signal source.</p>
--	---

Note: This function is only applicable to digital oscilloscopes with signal source channels.

Trigger control

	<p>Trigger level:</p> <p>Modify the trigger level. Turn clockwise to increase the level, and turn counterclockwise to decrease the level. During the modification, the trigger level line moves up and down, and at the same time, the value in the trigger level message box at the top right of the screen changes in real time.</p> <p>Press this knob to quickly restore the trigger level to the zero point of the trigger data source.</p>
	<p>TrigMenu:</p> <p>Press this key to open the trigger operation menu. This oscilloscope provides a variety of trigger types, please refer to the detailed introduction in "Trigger System".</p>
	<p>ForceTrig:</p> <p>A short press of this key will force a trigger signal.</p> <p>Press and hold this key to open the history waveform.</p>

Automatic waveform display

	<p>AutoScale:</p> <p>Press this key to enable the automatic waveform setting function. The oscilloscope will automatically adjust the vertical scale, horizontal time base, and trigger mode according to the input signal to achieve the best waveform display.</p>
---	---

Operational control

	<p>Run/Stop:</p> <p>Press this key to "run" or "stop" waveform sampling. In the Run state, the green backlight of the key is on; in the Stop state, the red backlight of the key is on.</p>
---	--

Single trigger

	<p>Single:</p> <p>Press this key to set the trigger mode of the oscilloscope to "Single". In single trigger mode, press the "Force Trig" key to immediately generate a trigger signal.</p>
---	---

Multifunction knob

	<p>V0:</p> <p>The multi-function knob can perform various settings, such as adjusting the waveform brightness, trigger time, selecting the trigger type, selecting the trigger source, the signal source waveform, frequency, offset, amplitude, etc.; the multi-function indi-</p>
---	--

indicator does not light up when the menu is not operated. The operation is that the multi-function indicator is on. Turn the knob to adjust the settings listed above. Turn clockwise to increase and counterclockwise to decrease. Press the knob to select this option.

Function menu

Default:

Press the key briefly to execute the corresponding default setting.

Long press this key to enter the Default function preset, you can choose factory settings, default settings, user settings.

Help:

Press this key to open and close the built-in help system.

Utility:

Press this key to enter the system function setting menu. Set system related functions or parameters, such as interface, sound, language, etc. In addition, some advanced features are supported, such as pass / fail tests.

Cursor:

Press this key to enter the cursor measurement menu. The oscilloscope provides two cursor modes: manual and tracking.

Measure:

Press this key to enter the measurement setting menu. You can set the measurement data source, turn the digital multimeter on or off, all measurements, and statistics functions. Press "All Measurements" to open the measurement of 42 waveform parameters, and the measurement results will appear at the bottom of the screen.

Save/Recall:

Press this key shortly to enter the file storage and recall interface. The types of files that can be stored include: setup, waveform, reference, CSV. Supports internal and external storage and disk management.

Long press this key to save the picture in .bmp format to external storage.

Display:

Press the key shortly to enter the display setting menu. Set the waveform display type, afterglow time, waveform brightness, screen grid and grid brightness.

Press and hold this key to clear the afterglow, and then collect or count again.

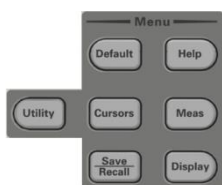

User interface

This section will let users know the front operation panel of this series of digital oscilloscopes before using.

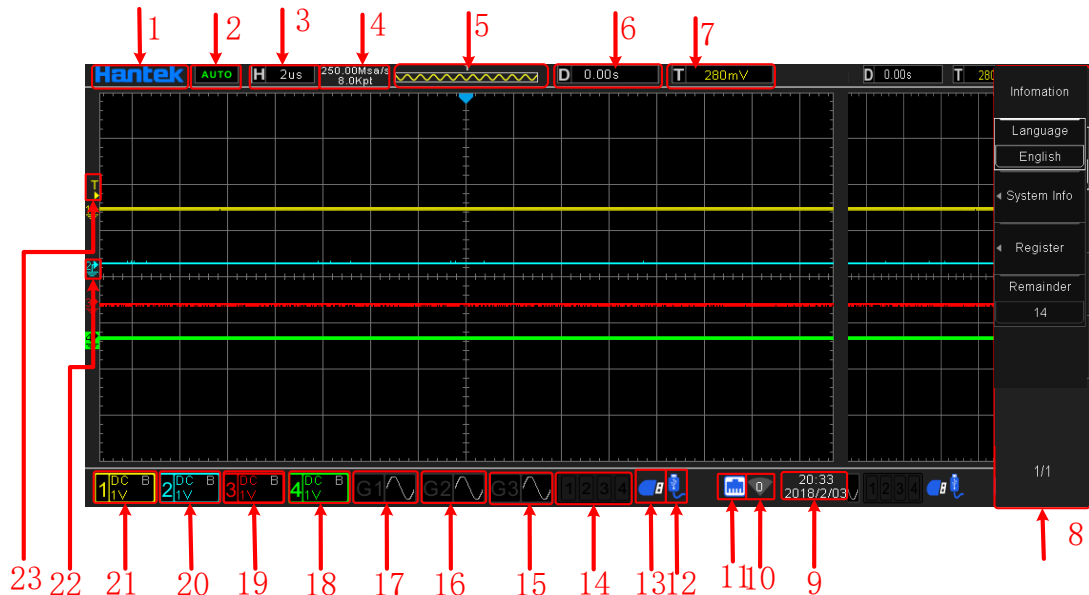

1. Hantek trademark

Open the "Touch Screen" in "Utility", and touch the Hantek logo in the upper left corner of the screen-> scan the QR code to quickly enter the wizard interface.

2. Running status:

AUTO: The oscilloscope works in automatic mode and acquires waveforms without triggers.

READY: All pre-trigger data has been acquired and the oscilloscope is ready to accept the trigger.

TD: The oscilloscope has been triggered.

ROLL: In scroll mode, the oscilloscope continuously acquires and displays waveform data.

STOP: The oscilloscope stops acquiring waveform data.

ARM: pre-trigger state.

3. The main time base of the current window

Represents the length of time represented by each division on the horizontal axis of the screen.

4. Current sampling rate, sampling points

Displays the current sampling rate and memory depth of the analog channels.

The sampling rate and memory depth change as the horizontal time base changes.

5. Waveform memory

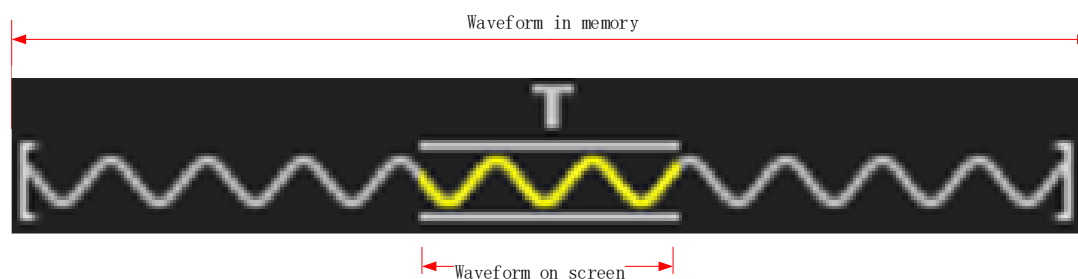

6. Horizontal trigger time

Use the horizontal offset knob to adjust this parameter. Press the knob to quickly reset the horizontal displacement.

7. Trigger Level

Use the trigger level knob to adjust this parameter. Press the knob to quickly reset the trigger level.

8. Operation menu displays different information of each function key

9. Time display of oscilloscope

10. WIFI status display

11. LAN connection status indication

If the icon is lit, the LAN is connected.

12. USB external storage device status display

If the icon is lit, the USB external storage device is connected.

13. USB host computer connection status display

If the icon is on, the USB host computer is connected.

14. Logic analyzer status display

If the icon is lit, the LA channel is connected.

15. Gen3 status display [MPO6000EDU series]

If the icon is lit, the Gen3 channel is turned on.

16. Gen2 status display [signal source series]

If the icon is lit, the Gen2 channel is turned on.

17. Gen1 status display [signal source series]

If the icon is lit, the Gen1 channel is turned on.

18. CH4 status display [4-channel series]

If the icon is lit, the CH4 channel is turned on.

19. CH3 status display [4-channel series]

If the icon is lit, the CH3 channel is turned on.

20. CH2 status display

If the icon is lit, the CH2 channel is turned on.

21. CH1 status display

If the icon is lit, the CH1 channel is turned on.

22. Channel zero-scale position display

23. Channel trigger level position display

Sampling system

To understand the oscilloscope's waveform acquisition system, you need to understand the sampling principle and understand the relationship between sampling rate and memory depth.

Sampling principle

According to the Nyquist sampling principle, in order to restore the analog signal without distortion, the sampling frequency should be greater than twice the highest frequency in the analog signal spectrum ($F_s > 2F_{max}$). The higher the sampling rate, the later the recovered waveform will be closer to the original signal, but the system requirements will be higher, and the conversion circuit must have a faster conversion speed.

Waveform aliasing

If the sampling cannot be satisfied ($F_s > 2F_{max}$), the waveform frequency when reconstructing the sampled data is smaller than the frequency of the actual signal. The most common aliasing is dithering on the fast edge.

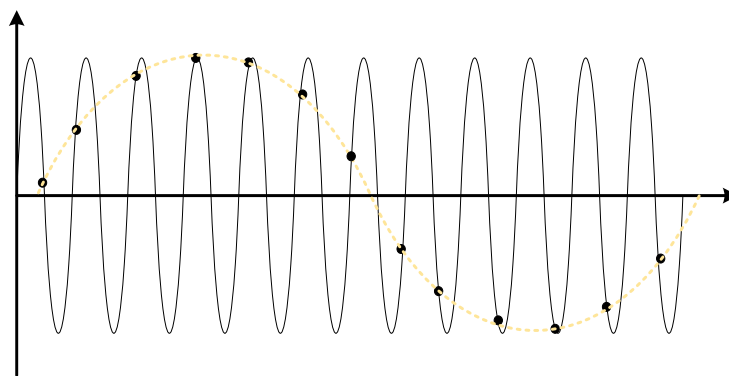

The following two measures can avoid aliasing:

1. Increase the sampling frequency to more than twice the highest signal frequency;
2. Introduce or increase the parameters of the low-pass filter; the low-pass filter is often called an anti-aliasing filter. Anti-aliasing filters can limit the bandwidth of the signal to meet the conditions of the sampling theorem. In theory, this is feasible, but it is impossible in practice. Because filters cannot completely filter out signals above the Nyquist frequency, there is always some "small" energy outside the bandwidth required by the sampling theorem. However, anti-aliasing filters can make these energies small enough to be negligible.

Waveform distortion

Due to the low sampling rate, some waveform details are missing, which makes the waveform displayed by the oscilloscope to be different from the actual waveform.

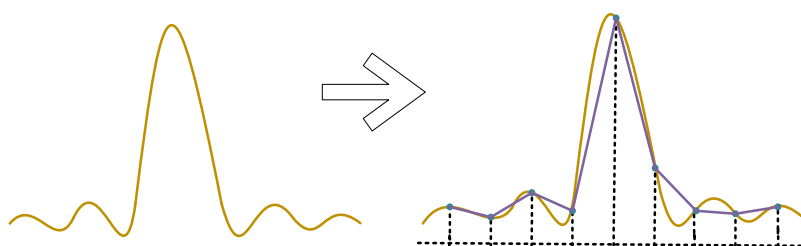

Waveform miss

Because the sampling rate is too low, the waveform when reconstructing the sampled data does not reflect all the actual signals.

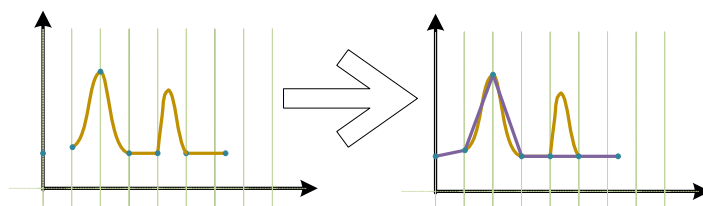

Sampling rate and memory depth

Sampling rate

The highest sampling rate of DPO6000 / MPO6000 is 1GSa/s. In the actual use of the oscilloscope, the sampling rate is determined by the current horizontal time base scale and storage depth. The sampling rate can be changed by adjusting the horizontal time base through the horizontal gear knob, or by switching the memory depth, the sampling rate value changes in real time and is displayed in the status bar at the top left of the screen.

Memory depth

Storage depth refers to the number of waveform points that the oscilloscope can store in one triggered acquisition, and it reflects the storage capacity of the acquisition memory. DPO6000 / MPO6000 series oscilloscopes have a maximum storage depth of 128Mpts.

The relationship between the oscilloscope's storage depth, sampling rate, and sampling time is as follows:

$$\text{Sampling time} = \text{memory depth} / (\text{sampling rate (Sa/s)})$$

For example: if the sampling rate is 1GSa/s and the storage depth is 32K, the actual sampling time is:

$$\text{Sampling time} = 3,2000 / 1,000,000,000 \text{ s} = 32 \times 10^{-6} \text{ s} = 32\mu\text{s}$$

Waveform interpolation

Under real-time sampling, the oscilloscope acquires discrete samples of the displayed waveform. In general, waveforms displayed by dots are difficult to observe. In order to increase the signal visibility, digital oscilloscopes generally use the interpolation display mode. The interpolation method is a processing method of "connecting various acquisition points" and using some points to estimate the entire shape of the waveform. For real-time sampling using interpolation, even if the oscilloscope only collects fewer sampling points in a single pass, interpolation can be used to fill in the gaps between points

and reconstruct accurate waveforms. The interpolation method is divided into sine interpolation, linear interpolation and step interpolation.

Linear interpolation

Connect straight lines directly at adjacent points. This method is limited to reconstructing straight-edge signals, such as square waves. The sine interpolation method uses curves to connect the sampling points, which is more versatile.

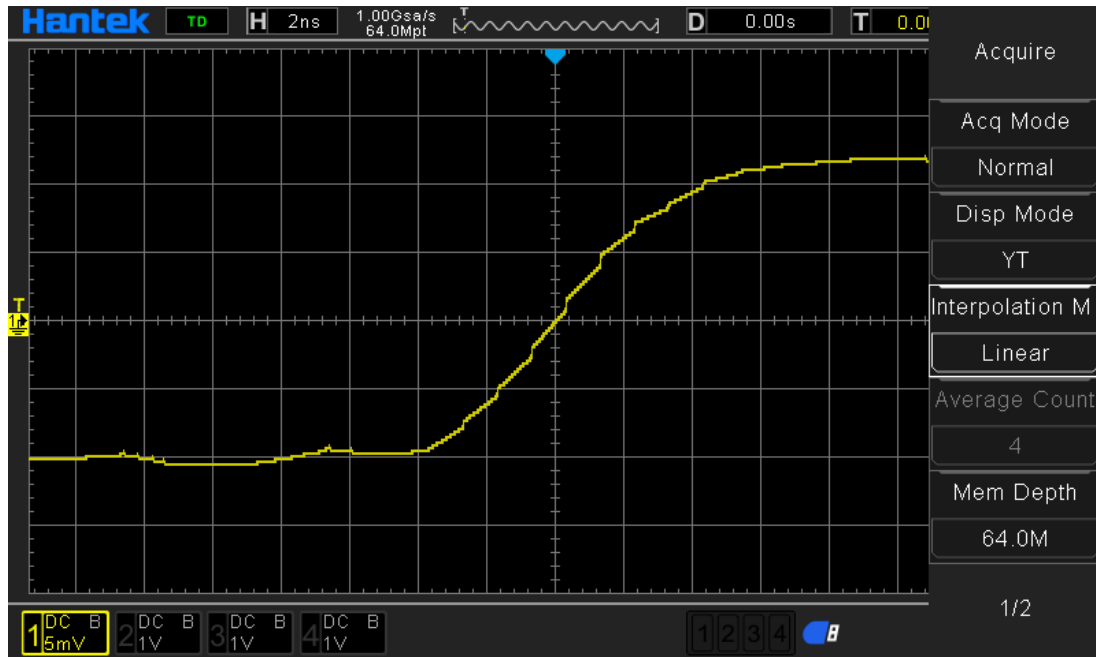

Step interpolation

Insert the value of the previous sampling point between adjacent samples. This interpolation algorithm is the same as the normal actual sampling of the oscilloscope ADC. The sample-and-hold method is used to interpolate data to improve the signal sampling rate.

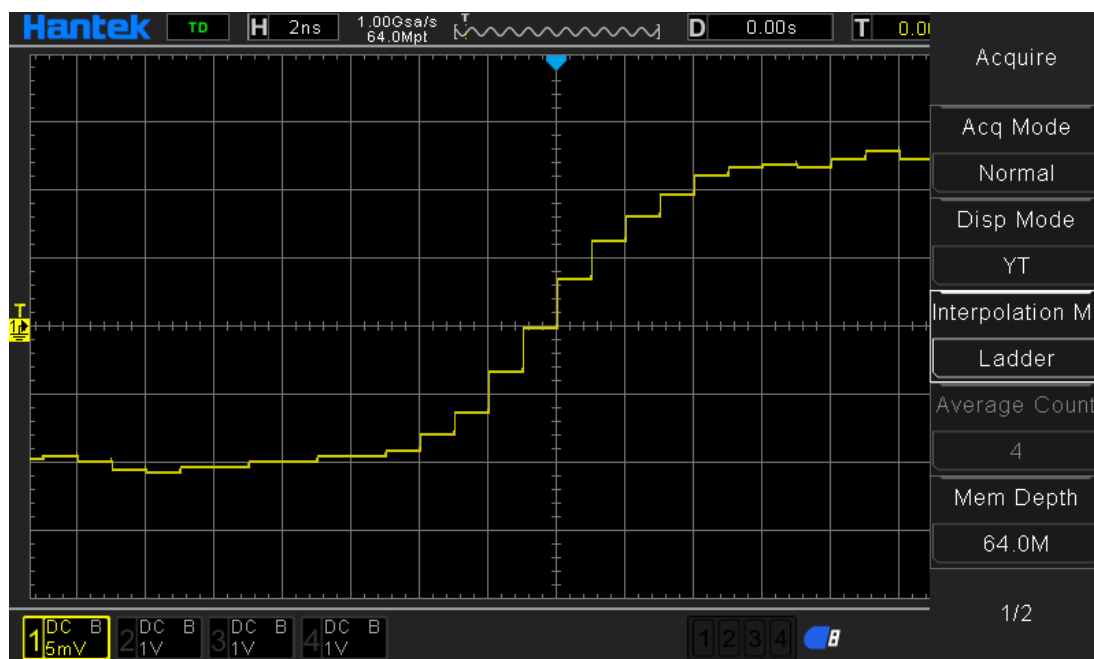

Sine interpolation

Use mathematical processing to calculate the results in the actual sample interval. This method bends the signal waveform to produce a more realistic common shape than pure square waves and pulses. When the sampling rate is 3 to 5 times the system bandwidth, sine interpolation is recommended. The following figure shows the completely different display effect after using this interpolation method.

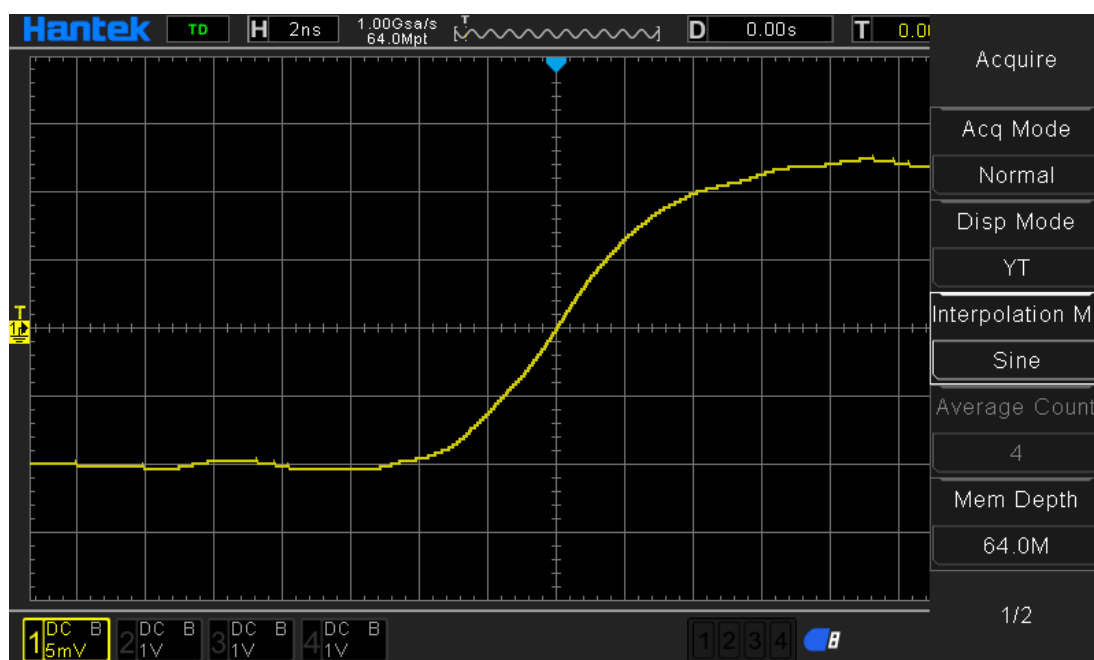

Through the comparison of the acquired signal waveforms of the three interpolation methods above, it can be clearly seen that the three interpolation methods, the sine interpolation method, are relatively smooth to fit the signal waveform, and also reflect the

signal waveform more realistically. For signal interpolation, we use sine interpolation by default.

Operational control

You can use the two buttons **Run/Stop** and **Single** on the front panel of the oscilloscope to start or stop the oscilloscope's sampling system.

When the **Run/Stop** key is green, the oscilloscope is running, that is, and the oscilloscope is acquiring data. To stop collecting data, press the **Run/Stop** key to display red, indicating that data collection has stopped. To capture and display a single acquisition, whether the oscilloscope is running or stopped, press **Single**. When the input single-shot signal meets the trigger conditions, the oscilloscope captures and stores and displays the waveform. At this time, even if there is another signal input to the oscilloscope, it will not be processed. If you want to capture again, you need to perform a single set-up again.

When the **Single** key is pressed, the trigger mode is temporarily set to "Normal" (to prevent the oscilloscope from triggering immediately and automatically), the button light is orange and the oscilloscope waits for the trigger condition to appear before displaying the waveform. When the oscilloscope triggers, the single acquisition result is displayed and the operation is stopped, and the **Run/Stop** key is displayed in red. Press the **Single** key again to acquire another waveform.

Collection method

Press the front panel **Utility**-> Acquisition-> Acquisition Mode, select the desired acquisition mode (the default is "normal"), press the knob to select this mode, and the user can also press the [Acquisition Mode] key continuously to switch.

Normal

In this mode, the oscilloscope samples the signal at equal time intervals to reconstruct the waveform. For most waveforms, using this mode produces the best display results.

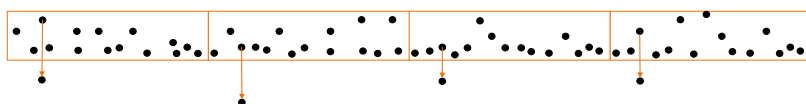

Peak

In this mode, the oscilloscope collects the maximum and minimum values of the signal during the sampling interval to obtain the signal envelope or narrow pulses that may be lost. Using this mode can avoid aliasing of the signal, but the display noise is relatively large.

In this mode, the oscilloscope can display all pulses that are at least as wide as the sampling period.

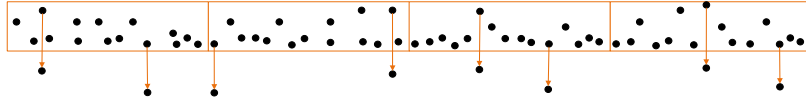

Average

In this mode, the oscilloscope averages the waveforms of multiple samples to reduce random noise on the input signal and improve vertical resolution. The higher the number of averages, the lower the noise and the higher the vertical resolution, but the slower the response of the displayed waveform to waveform changes.

DPO6000 / MPO600 series oscilloscopes use a stable average of the first n acquisitions, and then take the exponential average method. These two algorithms can always show the trend of changing waveforms. The stable average algorithm is as follows:

$$Ave_n = \frac{1}{n} \sum_{i=1}^n X_i = \frac{1}{n} \sum_{i=1}^{n-1} X_i + \frac{1}{n} X_n$$

$$Ave_n = \frac{n-1}{n} Ave_{n-1} + \frac{1}{n} X_n$$

Among them, Ave_n is the averaged sampling value, X_i is the i -th sampling value, and n is the current average number of times.

After selecting the "Average" mode, press the "Average Times" menu to set the desired average times, which can be set to 2, 4, 8, 16, 32, 64, 128, 256, 512, or 1024. The default is 2.

Example waveform without averaging:

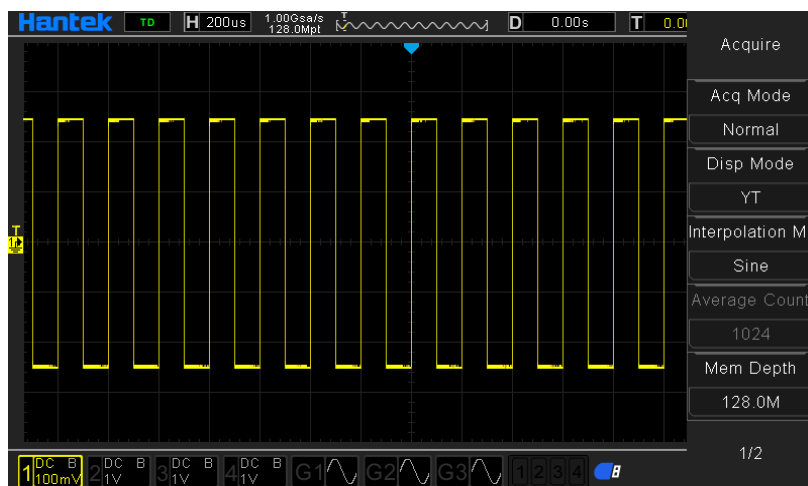

Example of waveform after 1024 averages:

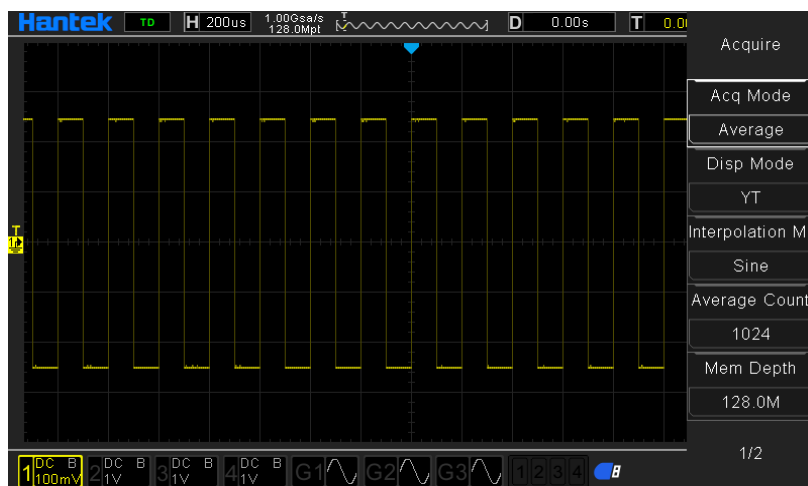

High resolution

This mode uses an oversampling technique to average the neighboring points of the sampled waveform to reduce random noise on the input signal and produce a smoother waveform on the screen. It is usually used when the sampling rate of the digitizer is higher than the storage rate of the acquisition memory.

The high-resolution mode is actually a low-pass filtering method, so the bandwidth of the measured signal is limited, that is, the measurement accuracy is improved by sacrificing the bandwidth of the measured signal. With the calculation of the number of adjacent points used, increasing the effective number of digits will increase accordingly. The DPO6000 / MPO6000 series oscilloscopes can be enhanced to a maximum of 12 digits.

In high-resolution mode, the oscilloscope is always running in the highest sampling rate mode, and the number of enhancement bits changes with the oscilloscope's time base.

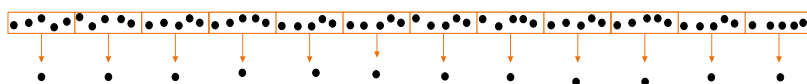

Note: The averaging method used by "Average" and "High Resolution" modes is different. The former is "Multiple Sampling Average" and the latter is "Single Sampling Average".

Sampling rate

The sampling rate is the number of times (Sa/s) that the oscilloscope samples the signal in unit time. DPO6000 / MPO6000 series oscilloscope single channel maximum real-time sampling rate of 1GSa/s, and will automatically switch according to the current acquisition mode, memory depth, time base settings, automatically calculate the appropriate sampling rate, without the need for users to manually set.

Function selection operation

By switching the memory depth {press the front panel **Utility**-> Acquisition-> Memory Depth}.

By selecting the horizontal time base knob {turn the front panel horizontal time base knob}.

By changing the acquisition method {press **Utility**-> Acquisition-> Acquisition Mode on the front panel}

Note: The current waveform sampling rate is displayed in the status bar at the top of the screen.

Horizontal control system

Time base mode

On the front panel, press the front-panel **Utility**-> Acquisition-> Display Mode menu. The F2 display mode control menu allows the user to select the desired time-base mode.

DPO6000 / MPO6000 series oscilloscopes include three time base display modes: YT mode, XY mode, and rolling mode [YT mode is the default].

YT mode

In this mode, the Y-axis represents the amount of normal voltage and the X-axis represents the amount of time.

Note: In this mode, when the horizontal time base is set to 100ms or more, the instrument enters the scan mode.

In YT mode, when the horizontal time base is set to 100ms/div or slower, the oscilloscope enters the scan mode. In this mode, the oscilloscope first collects the data to the left of the trigger point, and then waits for the trigger condition. Then continue to complete the waveform to the right of the trigger point and display the currently acquired waveform data.

Note: It is recommended to set the “channel coupling” mode to “DC” in the scan mode to observe the low signal frequency.

YT single window display mode

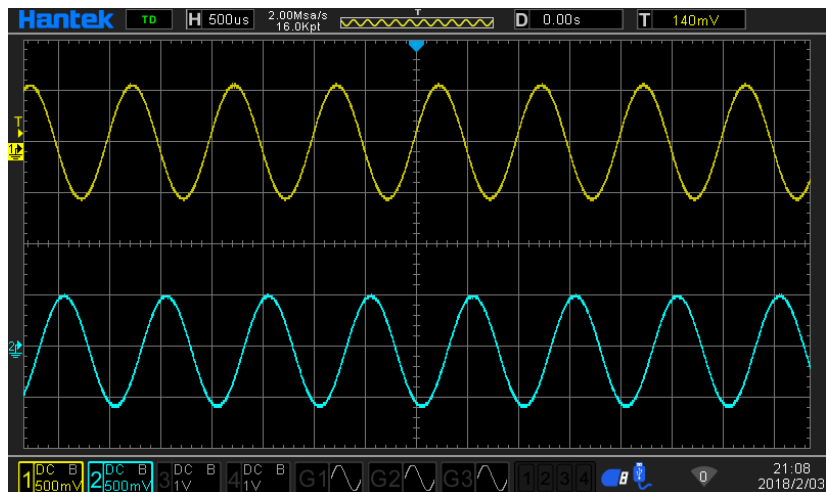

YT dual window display mode

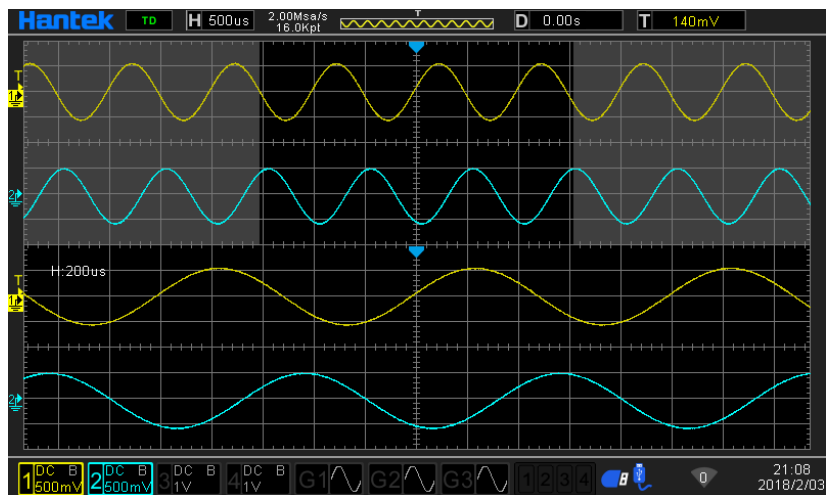

XY mode

In this mode, the oscilloscope converts the two input channels from voltage-time display to voltage-voltage display. The X-axis Y-axis combination can be CH1-CH2 or CH3-CH4. The Lissajous method can conveniently measure the phase difference between two signals at the same frequency. The figure below shows the measurement principle of phase difference.

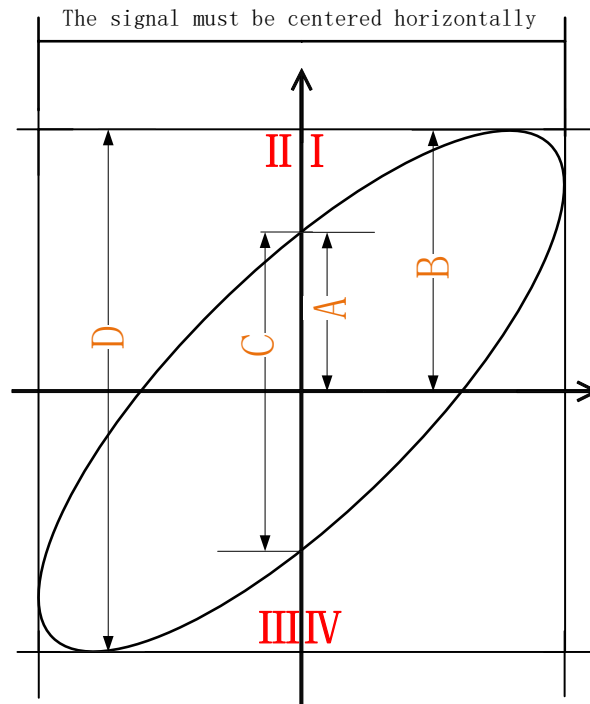

Phase difference measurement schematic

According to $\sin \theta = \frac{A}{B}$ or $\sin \theta = \frac{C}{D}$, θ is the phase difference angle between the channels, and the definitions of A, B, C, and D are shown in the figure above. Therefore, the phase difference angle can be obtained, that is:

$$\theta = \pm \arcsin \frac{A}{B} \text{ Or } \theta = \pm \arcsin \frac{C}{D}$$

If the major axis of the ellipse is in the quadrants I and III, then the obtained phase difference angle should be in the quadrant III, that is, within $(0 \text{ to } \pi / 2)$ or $(3\pi / 2 \text{ to } 2\pi)$. If the major axis of the ellipse is in the quadrants II and IV, then the obtained phase difference angle should be in the quadrants II and III, that is, within $(\pi / 2 \text{ to } \pi)$ or $(\pi \text{ to } 3\pi / 2)$. The X-Y function can be used to test the phase change of a signal through a circuit network. Connect the oscilloscope to the circuit and monitor the input and output signals of the circuit.

Note:

When XY mode is turned on, Scan Mode is automatically turned off.

In XY mode, the oscilloscope automatically selects the channel combination "CH1-CH2" or "CH3-CH4".

In XY mode: "Scan mode", "Vector display", "Protocol decoding", "Acquisition mode", "Pass / Fail test", "Digital channel", "Persistence time" have no effect.

XY single window display mode

Test example: measure the phase difference between the input signals of the two channels.

1. Connect a sinusoidal signal to CH1, and then connect a sinusoidal signal of the same frequency, same amplitude and 90° phase difference to CH2.
2. Press the AutoScale key and adjust the vertical displacement of the CH1 and CH2 channels to 0 V.
3. After selecting the display mode as XY mode, turn the horizontal time base knob and adjust the sampling rate appropriately to get better Lissajous graphics for better observation and measurement.
4. Adjust the vertical voltage scale of CH1 and CH2 to make the signal easy to observe. At this point, you should get the circle shown in the figure below.

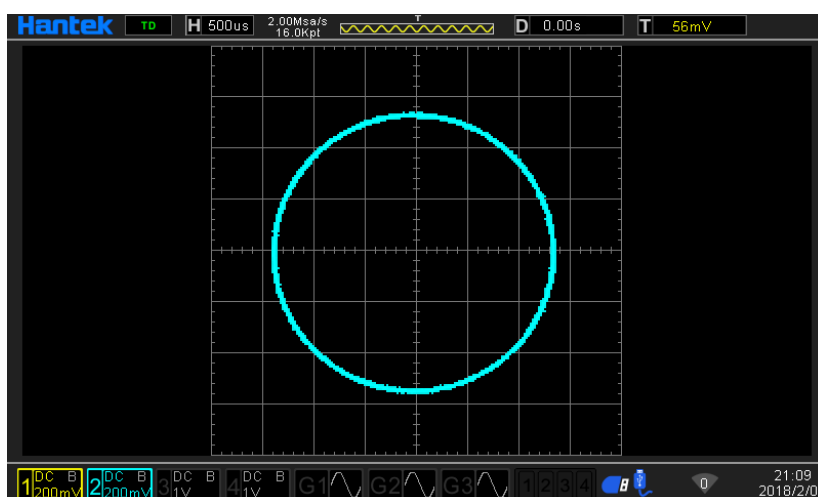

5. Observe the measurement results in the figure above, and according to the phase difference measurement principle diagram, you can get A/B (C/D) = 1, that is, the phase difference angle between the two channel input signals is $\theta = \pm \arcsin 1 = 90^\circ$.

XY dual window display mode

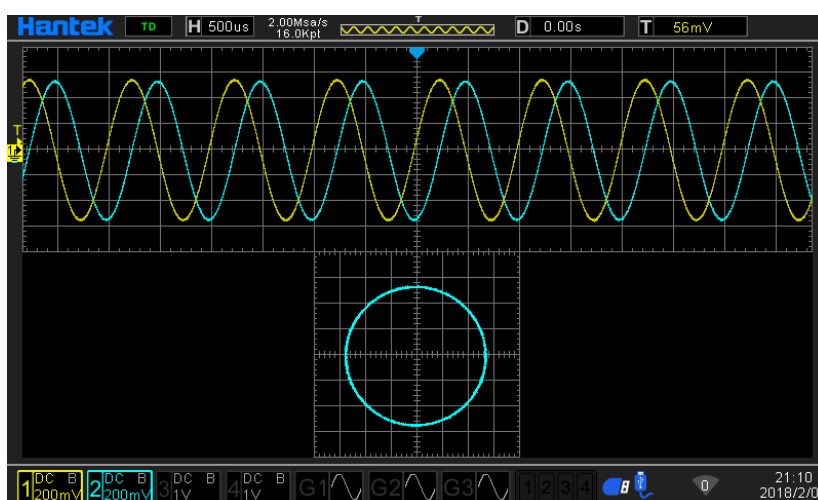

Roll mode

In this mode, the waveform scrolls from right to left to refresh the display. The adjustment range of the horizontal gear is 100ms to 100s.

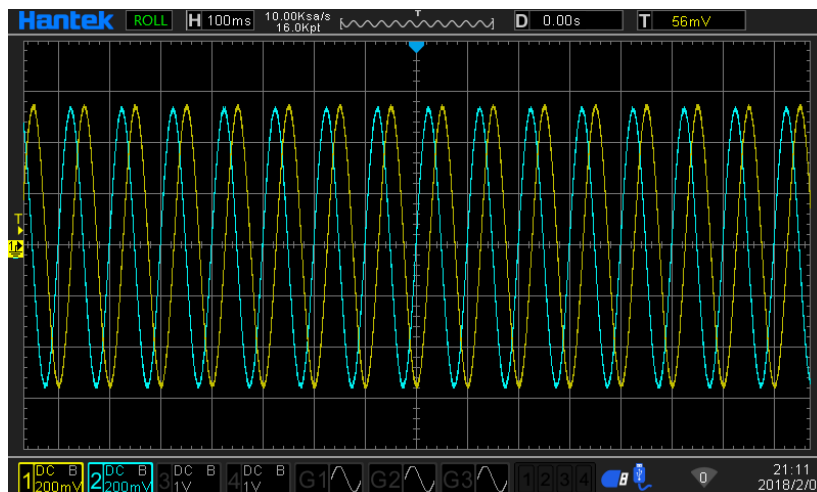

Note: When scroll mode is turned on, "Horizontal Shift", "Dual Window Mode", "Protocol Decoding", "Pass / Fail Test", "Segment Acquisition", "Persistence Time", and "Triggering Oscilloscope" have no effect.

Vertical control system

Enable analog channel

The DPO6000 / MPO6000 series provides 4 analog input channels CH1-CH4. The vertical system setting method of the 4 analog channels is exactly the same. This chapter uses CH1 as an example to introduce the vertical system setting method. After connecting a signal to the channel connector of CH1, press the **1** button on the front panel. The CH1 indicator lights up to indicate that CH1 is turned on. Press the **1** button again. The CH1 indicator turns off to indicate that CH1 is turned off.



Channel open



Channel close

Channel coupling

Setting the coupling mode can filter out unwanted signals. For example: the measured signal is a square wave signal with a DC offset.

- When the coupling method is DC: both the DC and AC components contained in the signal under test can pass.
- When the coupling mode is AC: The DC component contained in the measured signal is blocked.
- When the coupling method is ground: the DC and AC components contained in the signal under test are blocked.

Press **1**-> Coupling, and use to select the desired coupling method (default is DC). The current coupling mode will be displayed in the channel status label at the bottom of the screen. The user can also press the F1 [V0] key continuously to switch the coupling mode.

Show icon description:



Channel coupling method is AC.



Channel coupling method is DC.



Channel coupling method is GND.

Bandwidth limitation

DPO6000 / MPO6000 series oscilloscopes support bandwidth limiting functions. Setting a bandwidth limit can reduce noise in the displayed waveform. For example: the measured signal is a pulse signal containing high frequency oscillation. When the bandwidth limit is turned off, high-frequency components contained in the signal under test can pass. When the bandwidth limit is set to 20 MHz, the high-frequency components contained in the signal under test are attenuated.

Press the **1** key and press the F2 key continuously to switch the bandwidth limit state. The default is off, and a gray B is displayed in the channel menu. When the bandwidth limit is turned on, the character B is displayed in the corresponding channel status label at the bottom of the screen.

Note: Bandwidth limitation reduces or eliminates high-frequency components in the signal while reducing noise.

Show icon description:



Channel is full bandwidth



Channel opens 20M bandwidth limit

Waveform inversion

Press **1**-> Invert to turn the waveform inversion on or off. When the waveform inversion is turned off, the waveform is displayed normally; when the waveform inversion is turned on, the waveform voltage value is inverted (as shown in the figure below).

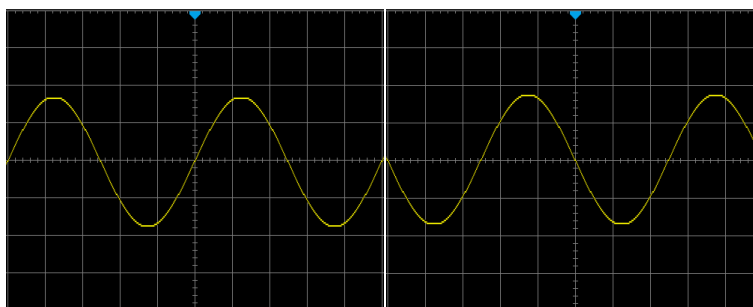

Inverted Off

Inverted On

Probe ratio

The DPO6000 / MPO6000 series allows the user to manually set the probe attenuation ratio. Press **1**-> Probe; use to select the required probe ratio. For details, refer to the “Technical Specifications” of the oscilloscope.

Vertical scale

The vertical scale, that is, the voltage value represented by each scale in the vertical direction of the display screen, is usually expressed as V/div. Press **1**. Rotate the vertical SCALE to adjust the vertical scale. You can see that the size of the displayed waveform changes. Turn clockwise to decrease the scale and turn counterclockwise to increase the scale. When adjusting the vertical scale, the scale information in the channel status label at the bottom of the screen changes in real time. The adjustment range of the vertical scale is related to the currently set probe ratio. By default, the probe ratio is X1, and the vertical scale can be adjusted from 500uV/div to 10V/div. There are two ways to adjust the vertical scale: “coarse” and “fine”. You can switch the adjustment mode by pressing the CH1 range.

- Coarse adjustment (counterclockwise as an example): Set the vertical scale by 1-2-5 steps, that is, 500uV/div, 1mV/div, 2mV/div, 5mV/div, 10mV/div, 20mV/div, 50mV/div, 100mV/div ... 10V/div.
- Fine adjustment: further adjust the vertical scale in a smaller range to improve the vertical resolution. If the amplitude of the input waveform is slightly larger than the full scale in the current scale, and the amplitude displayed by the waveform of the next gear is slightly lower, you can use fine adjustment to improve the waveform display amplitude to facilitate observation of signal details.

Note: "Coarse adjustment" and "Fine adjustment" can be selected not only through the amplitude scale menu, but also by pressing the vertical voltage scale quickly.

Analog channel delay setting

When using an oscilloscope for actual measurements, the propagation delay of the probe cable may introduce large errors (zero drift). DPO6000 / MPO6000 series oscilloscopes allow users to set a delay time to correct the zero offset of the corresponding channel. Zero offset is defined as the offset of the intersection of the waveform and the trigger level line relative to the trigger position, as shown in the figure below.

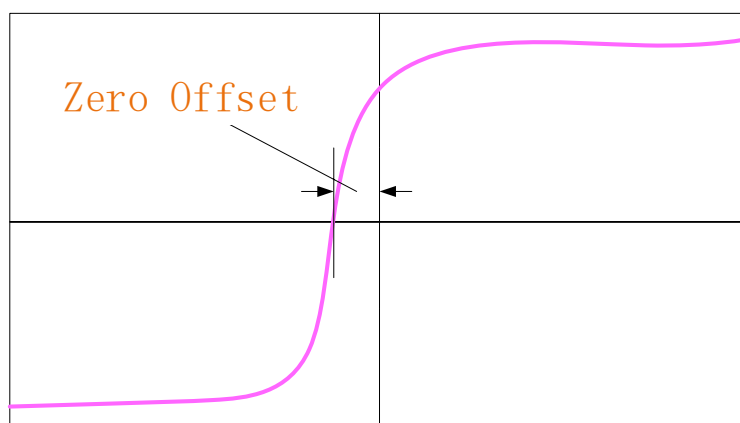

Delay correction. Turn the multi-function knob V0 to set the required delay correction time. This parameter can be set from -100ns to 100ns. Press the multi-function knob to restore the delay time to 0.00s.

Trigger system

Trigger can be understood as an event (or action); for example, the action of pressing the shutter when taking a picture is a trigger, which is an event that starts the camera to record an image. For an oscilloscope, the waveform (sampling data) will be recorded after the trigger condition is met and displayed on the screen. When a digital oscilloscope is working, whether or not the instrument triggers steadily, it always acquires waveforms continuously, but only stable triggers have a stable display. The trigger module ensures that each time-based scan or acquisition starts from a user-defined trigger condition, that is, each scan is synchronized with the acquisition, and the captured waveforms overlap to display a stable waveform.

The trigger setting should be based on the characteristics of the input signal, so the user should have some knowledge of the signal under test in order to quickly capture the required waveform. This oscilloscope provides a variety of trigger types, which is convenient for users to pay attention to the waveform details of interest.

The trigger determines when the oscilloscope starts acquiring data and displaying the waveform. Once the trigger is set up properly, the oscilloscope can convert unstable

displays or blank screens into meaningful waveforms. Here are some basic concepts of triggers.

Trigger source

Press the data source in the **Trig Menu**-> in the trigger control area on the front panel to select the required trigger data source. Analog channels CH1-CH4, digital channels D1.0-D1.3, D2.0-D2.3, D3.0-D3.3, D4.0-D4.3 can all be used as trigger data sources.

➤ Analog channel input:

The input signals of analog channels CH1-CH4 can all be used as trigger data sources. If the selected trigger source channel is not turned on, it is regarded as an invalid trigger.

➤ Digital channel input:

Only the digital channel connected to the oscilloscope can be used as the trigger data source. [Some trigger methods cannot be selected-such as slope, video, window, under Amp, etc.].

Acquisition process

The following is a schematic diagram of the acquisition process. To facilitate understanding of trigger events, the acquisition memory can be divided into pre-trigger memory and post-trigger memory.

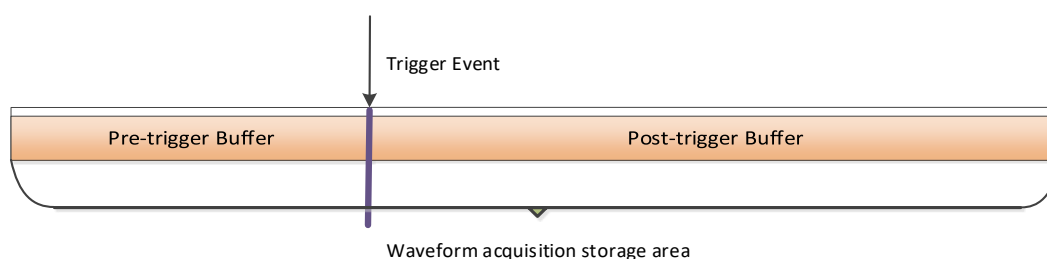

After the oscilloscope starts running, the oscilloscope stores the acquired data in the trigger memory area. After the acquisition is completed, the oscilloscope will start to search for trigger conditions; during the search for the trigger, the data collected by the oscilloscope will continue to be stored in the pre-trigger storage area (new data will continue to overwrite the existing data). Post-trigger store.

Trigger mode

Automatic mode allows free running acquisitions without a valid trigger. This mode allows untriggered sweep waveforms to occur at a time base setting of 100ms/div or slower. When the oscilloscope detects a valid trigger condition, it completes a triggered acquisition. When the oscilloscope detects that there is no valid trigger condition, a

non-trigger acquisition is completed.

Normal mode will update the displayed waveform only if the oscilloscope has a valid trigger. The oscilloscope will display the original waveform before replacing it with a new waveform. Use Normal mode only when you want to see a valid trigger waveform. When using this mode, the oscilloscope displays waveforms only after the first trigger.

Single Trigger Only when the oscilloscope has a valid trigger, it will stop after acquisition. To perform a single acquisition, press the **Single** button.

Trigger holdoff

Press the **TrigMenu** button to open the trigger menu and press the Hysteresis soft key. The trigger holdoff function can be used to generate stable and complex waveforms (such as AM columns) for display. "Holding off" refers to the time difference between the oscilloscope detecting one trigger and preparing to detect another trigger. During holdoff, the oscilloscope will not trigger. For a pulse train, you can adjust the holdoff time so that the oscilloscope triggers only on the first pulse in the train.

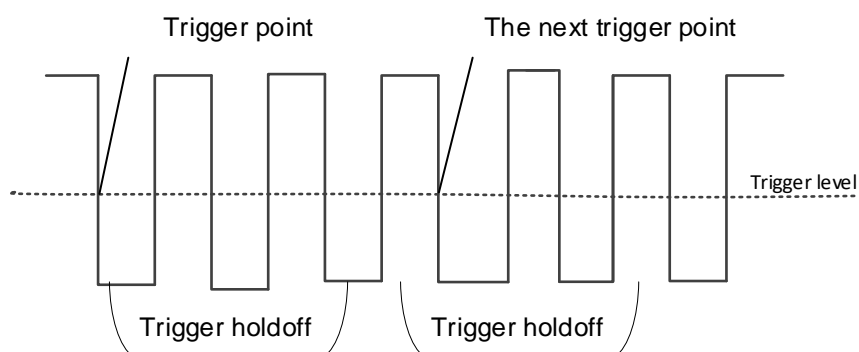

Trigger type

DPO6000 / MPO6000 series oscilloscopes have up to 16 trigger functions, as follows:

- (1) Edge trigger
- (2) Pulse trigger
- (3) Video trigger
- (4) Slope trigger
- (5) Overtime trigger
- (6) Window trigger
- (7) Pattern trigger
- (8) Interval trigger
- (9) Under Amp trigger

- (10) Delay trigger
- (11) Setup/Hold trigger
- (12) UART trigger [optional]
- (13) LIN triggering [optional]
- (14) CAN trigger [optional]
- (15) SPI triggering [optional]
- (16) IIC trigger [optional]

Edge trigger

Edge trigger types identify triggers by looking for a specified edge (rising, falling, rising, or falling) and voltage level on the waveform.

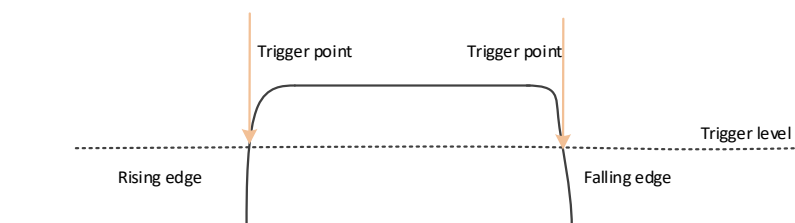

Press the front panel **Trig Menu** button to open the trigger function menu.

[Type] Select the edge and press **V0** to confirm.

[Data source] Select CH1~CH4 or LA as the trigger source.

Note: LA must be inserted when LA is used as the trigger source.

[Slope] Select the required triggering edge [rising edge, falling edge, double edge], and press **V0** to confirm.

[Mode] Select the acquisition mode [Auto, Normal] and press **V0** to confirm.

[50%] Set the trigger level to the vertical midpoint of the peak-to-peak value of the trigger signal. The trigger level value is displayed in the upper right corner of the screen.

[Holdoff] Set the holdoff time.

Trigger level knob: The analog channel can modify the trigger level value. The trigger mark moves up and down with the rotation of the knob. Turn the trigger level knob to adjust the trigger level to obtain a stable trigger.

Digital channel: You can change the trigger threshold of the digital channel by setting the threshold voltage.

Note: Pressing the Auto Scale button will set the trigger type to edge trigger and the

trigger slope to rising edge.

Pulse width trigger

Pulse width trigger sets the oscilloscope to trigger on a positive or negative pulse of a specified width. You can set the trigger source, polarity (positive pulse width, negative pulse width), limit conditions, and pulse width in this menu.

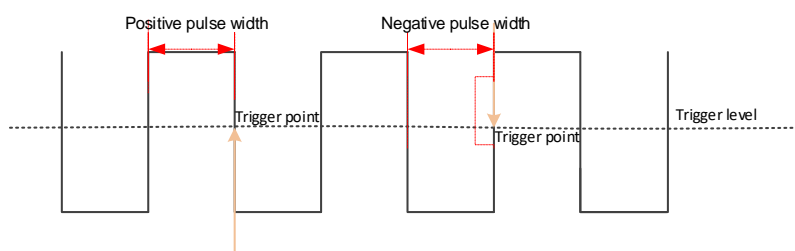

Press the front panel **Trig Menu** button to enter the trigger function menu.

[Type] Select the pulse width and press V0 to confirm.

[Data source] Select CH1~CH4 or LA as the trigger source.

Note: LA must be inserted when LA is used as the trigger source.

[Polarity] Select the positive or negative polarity of the trigger.

[When] Select the trigger conditions [$>$, $<$, $=$, \neq], And press V0 to confirm.

$>$ [Greater than the set time value]: When the positive or negative pulse width of the input signal is greater than the set pulse width, it can be triggered (pulse width error is 5%).

$<$ [Smaller than the set time value]: When the positive or negative pulse width of the input signal is smaller than the set pulse width, it can be triggered (pulse width error is 5%).

$=$ [Equal to the set time value]: When the positive or negative pulse width of the input signal is equal to the set pulse width, it can be triggered (pulse width error is 5%).

\neq [Not equal to the set time value]: When the positive or negative pulse width of the input signal is not equal to the set pulse width, it can be triggered (pulse width error is 5%).

[Width] Set the pulse width time from 8ns to 10s.

[50%] Set the trigger level to the vertical midpoint of the peak-to-peak value of the trigger signal. The trigger level value is displayed in the upper right corner of the screen.

[Mode] Select the acquisition mode [Auto, Normal] and press V0 to confirm.

[Holdoff] Set the holdoff time.

Trigger level knob: The analog channel can modify the trigger level value. The trigger mark moves up and down with the rotation of the knob. Turn the trigger level knob to adjust the trigger level to obtain a stable trigger.

Digital channel: You can change the trigger threshold of the digital channel by setting the threshold voltage.

Video trigger

Video triggers can be used to capture the complex waveforms of most standard analog and HD video signals. The trigger circuit detects the vertical and horizontal intervals of the waveform and generates a trigger based on the selected video trigger setting. This series of oscilloscopes support NTSC (National Television Standards Committee) and PAL etc.

Press the **Trig Menu** button on the front panel to enter the trigger function menu.

[Type] Select the video and press V0 to confirm.

[Data source] Select CH1~CH4 as the trigger source.

[Standard] Select the required video standard. The video standards supported by this series of oscilloscopes are: NTSC, PAL, HDTV720p, HDTV1080p, and HDTV1080i.

[Sync] Select the video trigger type [scan line, line number, odd field, even field, all fields].

Scan line: trigger on the first line found.

Line number: For NTSC and PAL / SECAM video standards, trigger on the specified line of "odd field" or "even field".

Note: When this synchronous trigger mode is selected, the line number can be changed in the "Number of Lines" menu item in steps of 1. The number of lines can be set from 1 to 525 [NTSC], 1 to 625 [PAL], 1 to 750 [720P], and 1 to 1125 [1080P / 1080i].

Odd field: Trigger on the rising edge of the first tooth pulse in the "odd field".

Even field: Trigger on the rising edge of the first tooth pulse in the "even field".

All fields: Trigger on the rising edge of the first tooth pulse in the odd / even fields.

[Line Number] Rotate V0 to set the number of video lines: 1 to 525 [NTSC], 1 to 625 [PAL], 1 to 750 [720P], 1 to 1125 [1080P / 1080i].

[Polarity] Select the video polarity [Positive polarity, Negative polarity].

[Mode] Select the acquisition mode [Auto, Normal] and press V0 to confirm.

[Holdoff] Set the holdoff time.

Trigger level knob: The analog channel can modify the trigger level value. The trigger mark moves up and down with the rotation of the knob. Turn the trigger level knob to adjust the trigger level to obtain a stable trigger.

Slope trigger

Slope trigger sets the positive or negative slope trigger of the oscilloscope from one level to another within a specified time.

As shown in the figure below, we define the time difference between the two points where the high and low trigger levels intersect with the rising (falling) edge of the waveform as the positive (negative) slope time.

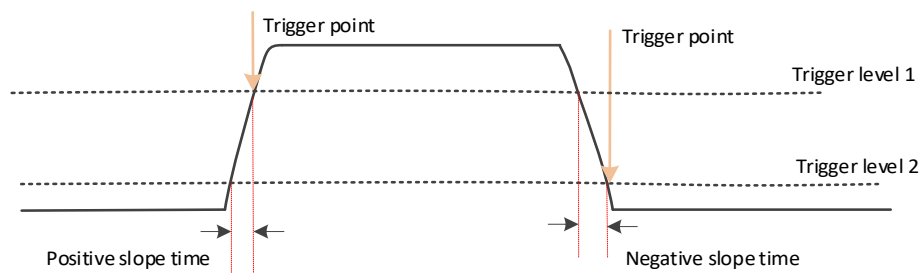

Press the front panel **Trig Menu** button to open the trigger function menu.

[Type] Select the slope and press V0 to confirm.

[Data source] Select CH1~CH4 as the trigger source.

[Slope] Select the required triggering edge [rising edge or falling edge].

[Level] Select low level [V2] or high level [V1], then turn the trigger level knob to adjust the vertical position of the high [low] level to obtain the required slope time T. The corresponding displacement information changes in real time and is displayed in the status bar in the upper right corner of the screen.

[When] Set the trigger condition ($>$, $<$, $=$, \neq), press V0 to confirm.

$>$ (Greater than the set time value): It can be triggered when the slope time of the rising or falling edge of the input signal is greater than the set slope time (pulse width error is 5%).

$<$ (Smaller than the set time value): It can be triggered when the slope time of the rising or falling edge of the input signal is smaller than the set slope time (pulse width error is 5%).

$=$ (Equal to the set time value): It can be triggered when the slope time of the rising or falling edge of the input signal is equal to the set slope time (pulse width error is 5%).

\neq (Not equal to the set time value): It can be triggered when the slope time of the rising or falling edge of the input signal is not equal to the set slope time (pulse width error is 5%).

[Time] Set slope time reference (8ns~10s), the slope time is the horizontal time interval between the intersection of the high and low levels and the rising or falling edge of the waveform.

[Mode] Select the acquisition mode [Auto, Normal] and press V0 to confirm.

[Holdoff] Set the hysteresis time.

Trigger level knob: The analog channel can modify the trigger level value. The trigger mark moves up and down with the rotation of the knob. Turn the trigger level knob to adjust the trigger level to obtain a stable trigger.

Overtime trigger

Trigger when the time interval (ΔT) from the rising edge (or falling edge) of the input signal passes the trigger level to the end of the adjacent falling edge (or rising edge) pass the trigger level is greater than the set overtime period. As shown below:

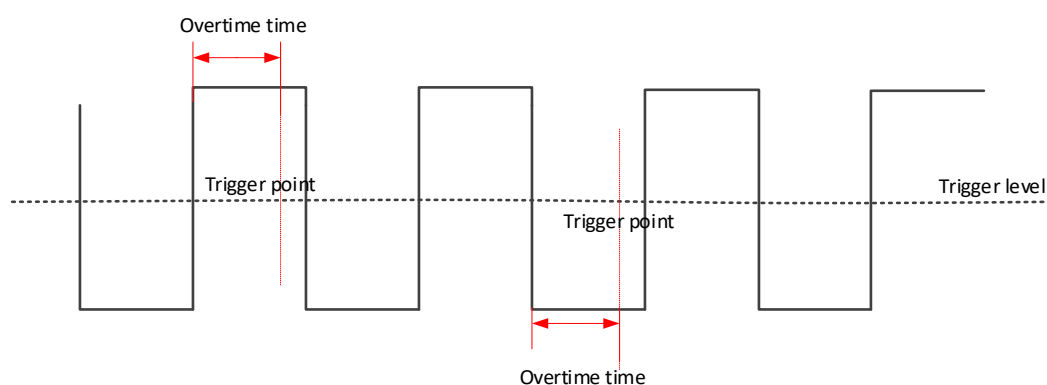

Press the front panel **Trig Menu** button to open the trigger function menu.

[Type] Select overtime and press V0 to confirm.

[Data source] Select CH1~CH4 or LA as the trigger source.

Note: LA must be inserted when LA is used as the trigger source.

[Polarity] Select the positive or negative polarity of the trigger.

[Time] Set the pulse width time (8ns~10s).

[50%] Set the trigger level to the vertical midpoint of the peak-to-peak value of the trigger signal. The trigger level value is displayed in the upper right corner of the screen.

[Mode] Select the acquisition mode (auto, normal) and press V0 to confirm.

[Holdoff] Set the holdoff time.

Trigger level knob: The analog channel can modify the trigger level value. Turn the trigger level knob to adjust the

trigger level to obtain a stable trigger.

Digital channel: You can change the trigger threshold of the digital channel by setting the threshold voltage.

Window trigger

Window triggering provides high and low trigger levels. When the input signal passes the high or low trigger level, the oscilloscope triggers.

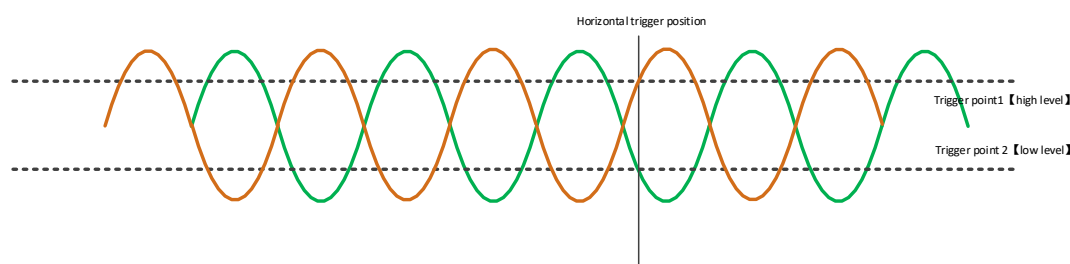

If both the high and low levels are within the waveform range, the waveform is triggered on the rising or falling edge at the same time.

If the high level is within the waveform range and the low level is outside the waveform range, the waveform will only trigger on the rising edge.

If the high level is outside the waveform range and the low level is within the waveform range, the waveform will only trigger on the falling edge.

Press the front panel **Trig Menu** button to open the trigger function menu.

[Type] Select the window and press V0 to confirm.

[Data source] Select CH1~CH4 as the trigger source.

[Level] Enable the high / low level setting function, continue to press this soft key, select low level (V2) or high level (V1), and then turn the trigger level knob to adjust the vertical position of the high (low) level. The corresponding displacement information changes in real time and is displayed in the status bar in the upper right corner of the screen.

[Mode] Select the acquisition mode (auto, normal) and press V0 to confirm.

[Holdoff] Set the holdoff time.

Trigger level knob: The analog channel can modify the trigger level value. Trigger the mark and move up and down with the knob. Turn the trigger level knob to adjust the trigger level to obtain a stable trigger.

Pattern trigger

Identify trigger conditions by looking for specific patterns. This pattern is a logical AND

and OR combination between channels. Each channel can have a value of high (1), low (0), or inactive (X). In the pattern trigger mode, the oscilloscope will compare the actual pattern of the channel with the preset pattern, and trigger on the last channel that is the same as the preset pattern (the pattern is true). If the pattern of each channel is fixed or the pattern of all channels is set to "Invalid", the oscilloscope will not trigger.

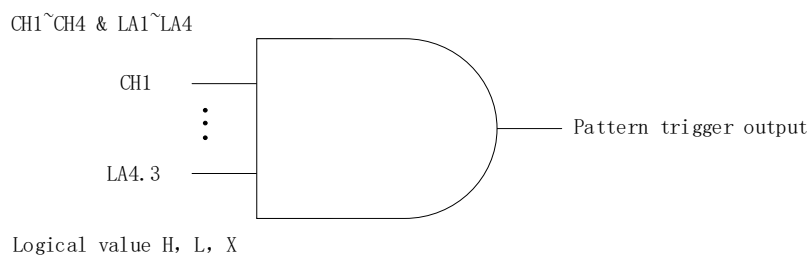

Press the front panel **Trig Menu** button to open the trigger function menu.

[Type] Select the code type and press V0 to confirm.

[Data source] Select CH1~CH4 or LA as the trigger source.

Note: LA must be inserted when LA is used as the trigger source.

[Current channel pattern] Set the current channel pattern. Press V0 to confirm. The preset pattern is displayed in the upper left corner of the screen.

1: Set the channel pattern to "H", that is, the level is higher than the trigger level of the channel.

0: Set the channel pattern to "L", that is, the level is lower than the trigger level of the channel.

X: Set the channel pattern to "X", that is, this channel is not used as part of the pattern.

[Mode] Select the acquisition mode (auto, normal) and press V0 to confirm.

[Holdoff] Set the holdoff time.

Trigger level knob: Press the channel button first and then move the trigger level knob to modify the trigger level value of the corresponding channel. Trigger the mark and move up and down with the knob. Turn the trigger level knob to adjust the trigger level to obtain a stable trigger. For example, set the CH1 trigger level. Press soft key **CH1** to use the trigger level to modify the level.

Digital channel: You can change the trigger threshold of the digital channel by setting the threshold voltage.

Interval trigger

Triggered when the interval between two consecutive rising edges (or falling edges)

meets the set time condition ($>$, $<$, $=$, \neq).

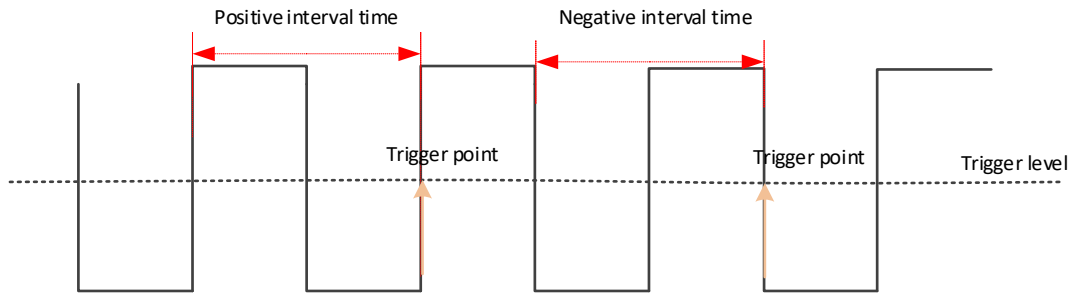

Press the front panel **Trig Menu** button to open the trigger function menu.

[Type] Select the interval and press V0 to confirm.

[Data source] Select CH1~CH4 or LA as the trigger source.

Note: LA must be inserted when LA is used as the trigger source.

[Slope] Select the positive or negative polarity of the trigger.

[When] Select the trigger condition ($>$, $<$, $=$, \neq), And press V0 to confirm.

$>$ [Greater than the set time value]: It can trigger when the interval between two rising or falling edges is greater than the set reference time (pulse width error is 5%).

$<$ [Smaller than the set time value]: It can trigger when the interval between two rising or falling edges is smaller than the set reference time (pulse width error is 5%).

$=$ [Equal to the set time value]: It can trigger when the interval between two rising or falling edges is equal to the set reference time (pulse width error is 5%).

\neq [Not equal to the set time value]: It can trigger when the interval between two rising or falling edges is not equal to the set reference time (pulse width error is 5%).

[Time] Set the reference time (8ns~10s).

[Mode] Select the acquisition mode (auto, normal) and press V0 to confirm.

[Holdoff] Set the holdoff time.

Trigger level knob: The analog channel can modify the trigger level value. Trigger the mark and move up and down with the knob. Turn the trigger level knob to adjust the trigger level to obtain a stable trigger.

Digital channel: You can change the trigger threshold of the digital channel by setting the threshold voltage.

Under Amp trigger

Under Amp triggering is used to trigger pulses that cross one trigger level but not another trigger level, as shown in the figure below:

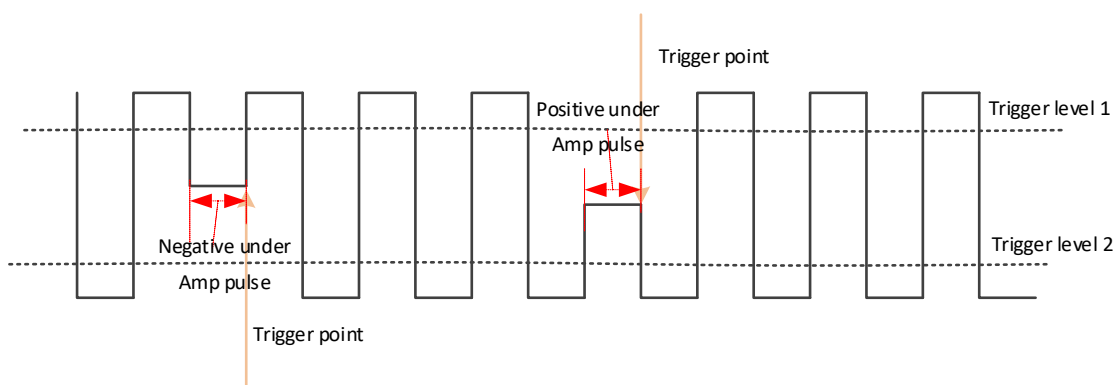

- Positive runt: The pulse crosses the low level but not the high level.
- Negative runt: The pulse crosses the high level but not the low level.

Set Under Amp trigger:

Press the front panel **Trig Menu** button to open the trigger function menu.

[Type] Select runt and press V0 to confirm.

[Data source] Select CH1~CH4 as the trigger source.

[Polarity] Select the positive or negative polarity of the trigger.

[When] Set the trigger condition ($>$, $<$, $=$, \neq) and press V0 to confirm.

$>$ [Greater than the set width value]: It can be triggered when the negative pulse width or the positive pulse width is greater than the set width (pulse width error is 5%).

$<$ [Smaller than the set width value]: It can be triggered when the negative pulse width or the positive pulse width is smaller than the set width (pulse width error is 5%).

$=$ [Equal to the set width value]: It can be triggered when the negative pulse width or the positive pulse width is equal to the set width (pulse width error is 5%).

\neq [Not equal to the set width value]: It can be triggered when the negative pulse width or the positive pulse width is not equal to the set width (pulse width error is 5%).

[Width] Set the reference time (8ns~10s) for the negative pulse width (or positive pulse width) when the pulse crosses the high level but does not cross the low level (or crosses the low level but does not cross the high level).

[Level] Enable the high / low level setting function, continue to press this soft key, select low level (V2) or high level (V1), and then turn the trigger level knob to adjust the vertical position of the high (low) level. The corresponding displacement information changes in real time and is displayed in the status bar in the upper right corner of the screen.

[Mode] Select the acquisition mode (auto, normal) and press V0 to confirm.

[Holdoff] Set the holdoff time.

Trigger level knob: You can modify the trigger level value. Trigger the mark and move up and down with the knob. Turn the trigger level knob to adjust the trigger level to obtain a stable trigger.

Delay trigger

Under the delay trigger type, the user needs to set trigger data source 1 and data source 2. When the time difference between the edge (edge 1) set by data source 1 and the edge (edge 2) set by data source 2 meet the preset time limit, the oscilloscope triggers, as shown in the figure below.

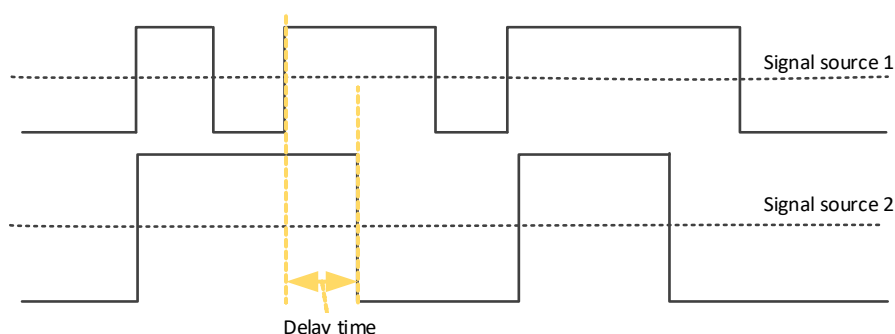

Note: Edge 1 and Edge 2 must be immediately adjacent edges.

Press the front panel **Trig Menu** button to open the trigger function menu.

[Type] Select the delay and press V0 to confirm.

[Data source 1] Select CH1~CH4 or LA as the trigger source.

Note: LA must be inserted when LA is used as the trigger source.

[Slope 1] Select the required triggering edge (rising or falling edge)

[Data source 2] Select CH1~CH4 or LA as the trigger source.

Note: LA must be inserted when LA is used as the trigger source.

[Slope 2] Select the required triggering edge (rising or falling edge)

[When] Set the trigger condition and press V0 to confirm.

> [Greater than the set width value]: Trigger when the time difference between the set edges is greater than the set width (pulse width error is 5%).

< [Smaller than the set width value]: Trigger when the time difference between the set edges is smaller than the set width (pulse width error is 5%).

= [Equal to the set width value]: Trigger when the time difference between the set

edges is equal to the set width (pulse width error is 5%).

≠ [Not equal to the set width value]: Trigger when the time difference between the set edges is not equal to the set width (pulse width error is 5%).

[Width] Set the reference value of the time difference between the edges set by the two data sources (8ns~10s).

[Mode] Select the acquisition mode (auto, normal) and press V0 to confirm.

[Holdoff] Set the holdoff time.

Trigger level knob: Press the channel button first and then move the trigger level knob to modify the trigger level value of the corresponding channel. Trigger the mark and move up and down with the knob. Turn the trigger level knob to adjust the trigger level to obtain a stable trigger. For example, set the CH1 trigger level. Press soft key **[CH1]** to use the trigger level to modify the level.

Digital channel: You can change the trigger threshold of the digital channel by setting the threshold voltage.

Setup/Hold trigger

Under the setup/hold trigger type, the user needs to set the data signal line and clock signal line. The setup time starts when the data signal crosses the trigger level and ends when the specified clock edge arrives; the hold time starts when the specified clock edge arrives and ends when the data signal crosses the trigger level again (as shown in the figure below). The oscilloscope will trigger when the setup time or hold time is less than the preset time.

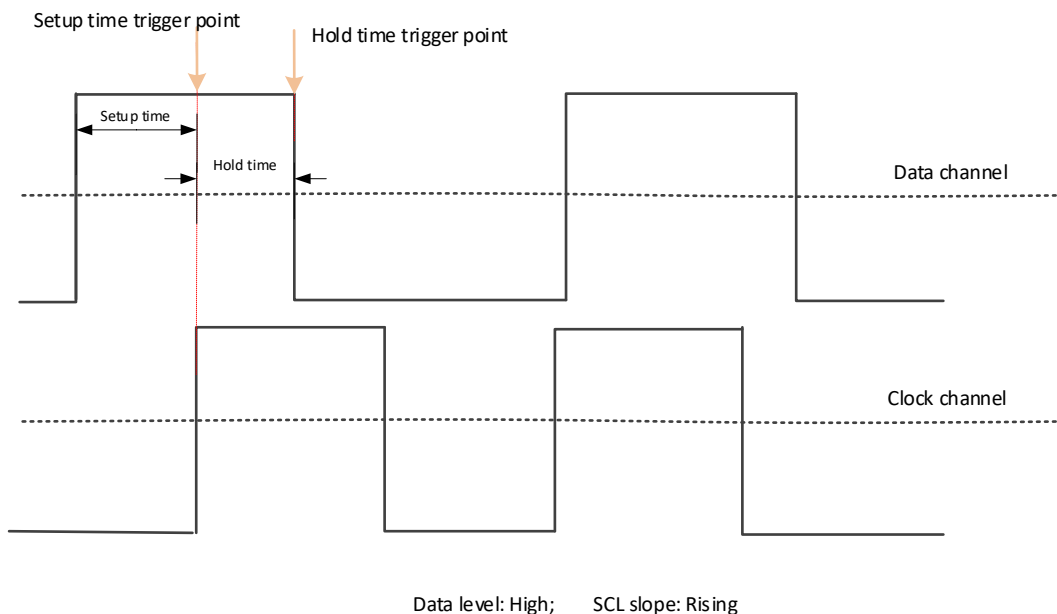

Press the front panel **[Trig Menu]** button to open the trigger function menu.

[Type] Select Build Hold and press V0 to confirm.

[Data] Select CH1~CH4 or LA as the trigger source.

Note: LA must be inserted when LA is used as the trigger source.

[Data type] Select high level or low level.

[Clock] Select CH1~CH4 or LA as the trigger source of the clock channel.

Note: LA must be inserted when LA is used as the trigger source.

[Slope] Select the required triggering edge (rising edge or falling edge).

[Polarity] Select the hold type (establish or hold).

Setup: The time when the data is stable before the clock edge arrives.

Hold: The time when the data is stable after the clock edge arrives.

[Width] Set the setup time and hold time separately.

[Mode] Select the acquisition mode (auto, normal) and press V0 to confirm.

[Holdoff] Set the holdoff time.

Trigger level knob: Press the channel button first and then move the trigger level knob to modify the trigger level value of the corresponding channel. Trigger the mark and move up and down with the knob. Turn the trigger level knob to adjust the trigger level to obtain a stable trigger. For example, set the **CH1** trigger level. Press soft key CH1 to use the trigger level to modify the level.

Digital channel: You can change the trigger threshold of the digital channel by setting the threshold voltage.

UART trigger [optional]

UART bus is a serial communication method used for data transfer between computers or between computers and terminals. The UART serial protocol transmits a character as a frame of data, and its frame structure is composed of a 1-bit start bit, 5-8 bits data bit, 1-bit check bit, and 1--2 bit stop bit.

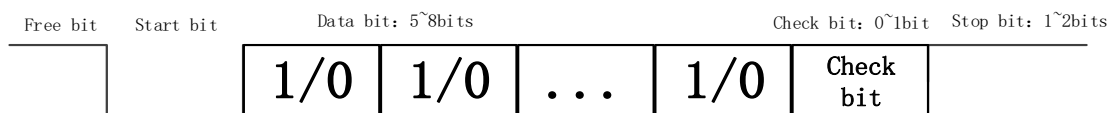

Its format is shown above. DPO6000 / MPO6000 series oscilloscope can trigger when it detects the frame start, stop bit, data, parity error or data bit error of the UART signal.

Press the **Trig Menu** button on the front panel to enter the trigger function menu.

[Type] Select UART and press V0 to confirm.

[Data source] Select CH1~CH4 or LA as the trigger source.

Note: LA must be inserted when LA is used as the trigger source.

[Baud rate] Select the baud rate.

DPO6000 / MPO6000 series machines provide users with common baud rates as follows:

110	300	600	1200	2400
4800	9600	14400	19200	38400
57600	115200	230400	380400	460400
Custom				

If the user does not find the required baud rate in the above table, you can select Custom and then set the required baud rate.

[Custom] Users set their own baud rate {only available if you choose to customize this menu}

[When] Set UART trigger conditions:

Start bit: When the UART start bit appears, trigger in the middle of the bit.

Stop bit: When the UART stop bit appears, trigger in the middle of the bit. Regardless of whether the stop bit of the device under test is 1, 1.5 or 2, this series of oscilloscopes will handle it as 1 bit.

Data: The normal reception of data is completed, and the received UART data and user-set data are equal to trigger at the stop bit.

Parity error: The normal reception of data is completed. When a parity error occurs in the data, it is triggered at the stop bit.

Data bit error: When the data is checked at the stop bit of the start bit, it is triggered when an error occurs.

[Idle level] The level value (level / high level) when the UART is idle. The default setting is high level.

[Parity check] Set whether the measured UART data is checked (odd check, even check or none).

[Data bits] Set the length of the UART data to be measured (5, 6, 7, 8 bits can be selected).

[Data] The trigger data set by the user (only available when the trigger type is data).

[Mode] Select the acquisition mode (auto, normal) and press V0 to confirm.

[Holdoff] Set the holdoff time.

[Decode] Switch the decoding function.

[Label position] The position of the decoded data drawn on the screen can be changed with the V0 knob (only available when the decode function is turned on).

[Table] Data recording mode.

Trigger level knob: The analog channel can modify the trigger level value. The trigger mark moves up and down with the rotation of the knob. (The digital channel can change the trigger threshold of the digital channel by setting the threshold voltage.)

Trigger setting example:

Data source: CH1; baud rate: 19200; When: Start; Idle level: High; Parity: None; Data bits: 8. Adjust the trigger level, the trigger result is displayed as follows:

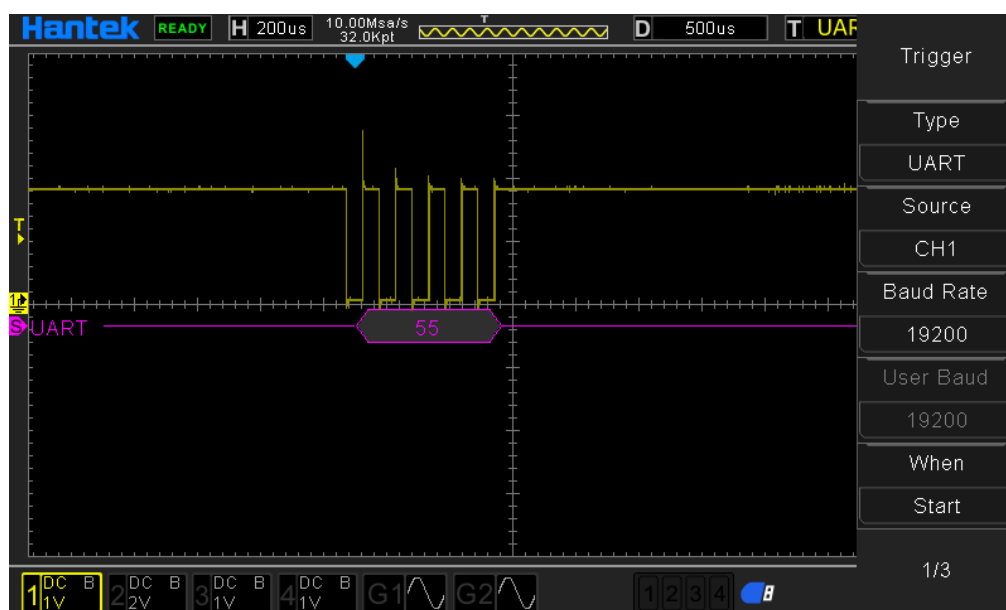

UART decoding explanation:

1. The decoded data is displayed in hexadecimal;
2. The decoded data shows purple;
3. When "?", "Please adjust the time base" or "Please adjust the trigger (no trigger)" appears, you need to adjust the time base or trigger to get the decoding result.

LIN trigger [optional]

The LIN bus is a low-cost serial communication network defined for automotive distributed electronic systems. It is a supplement to other automotive multiplex networks such as the controller area network (CAN). It is suitable for network bandwidth and performance. Or applications where fault tolerance is not too demanding. The LIN bus is based on the SCI (UART) data format and uses a single-master / multi-slave mode, which is a special case in the UART.

The LIN signal message frame is displayed as follows:

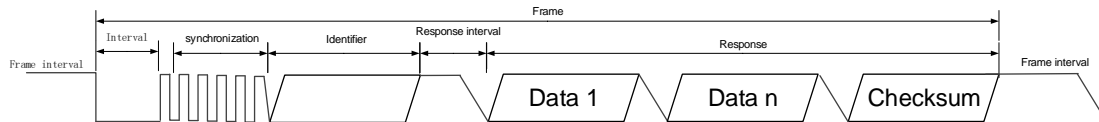

Press the front panel **Trig Menu** button to open the trigger function menu.

[Type] Select LIN and press V0 to confirm

[Data source] Select CH1~CH4 or LA as the trigger source.

Note: LA must be inserted when LA is used as the trigger source.

[Baud rate] Select the baud rate.

DPO6000 / MPO6000 series machines provide users with common baud rates as follows:

110	300	600	1200	2400
4800	9600	14400	19200	38400
57600	115200	230400	380400	460400
Custom				

If the user does not find the required baud rate in the above table, you can select Custom and then set the required baud rate.

[Custom] Users set their own baud rate {only available by selecting Customize this menu}.

[When] Set LIN trigger conditions:

Interval field: The edge is triggered when the LIN gap ends.

Sync field: LIN sync field data completion trigger.

ID field: LINID field data reception completion trigger.

Sync Code error: trigger when LIN sync field data is received but the sync field data is not equal to 0x55.

Identifier: Triggered when the LINID field data is received and the ID data is equal to the ID set by the user.

ID and data: LIN data is received normally. ID and data are equal to the data set by the user.

[Identifier] The identifier data when LIN is triggered.

[Data 1] Data when LIN is triggered.

[Data 2] Data when LIN is triggered.

[Data 3] LIN trigger data.

[Data 4] LIN trigger data.

[Idle level] The level value (level / high level) at the LIN frame interval. The default setting is high level.

[Mode] Select the acquisition mode (auto, normal) and press V0 to confirm.

[Holdoff] Set the holdoff time.

[Decode] Switch the decoding function.

[Label position] The position where the decoded data is drawn on the screen (only available when the decode function is turned on).

[Table] Data recording mode.

Trigger level knob: The analog channel can modify the trigger level value. The trigger mark moves up and down with the rotation of the knob. (The digital channel can change the trigger threshold of the digital channel by setting the threshold voltage.)

Trigger setting example:

Data source: CH1; Baud rate: 19200; When: interval field; Idle level: High; Adjust the trigger level, the trigger result is displayed as follows:

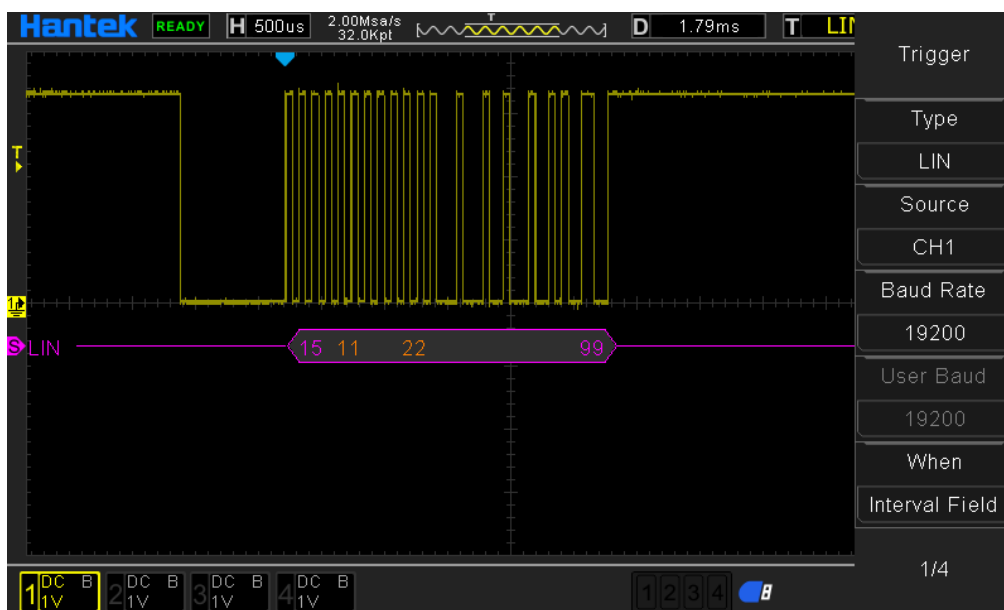

LIN decoding explanation:

1. Decoded data is displayed in hexadecimal;
2. The "Identifier" and "Checksum" display colors are purple, and the "Data" display color is orange;
3. When "?", "Please adjust the time base" or "Please adjust the trigger (no trigger)" appears, you need to adjust the time base or trigger to get the decoding result.

4. In the LIN decoding result, the synchronous field "55" is not displayed.

CAN trigger [optional]

CAN is the abbreviation of Controller Area Network (CAN). It was developed by the German company BOSCH, which is famous for R & D and production of automotive electronics. Eventually it became the international standard (ISO 11898), which is the most widely used internationally. Fieldbus one. In North America and Western Europe, the CAN bus protocol has become the standard bus for automotive computer control systems and embedded industrial control area networks, and it has the J1939 protocol designed for large trucks and heavy industrial vehicles with CAN as the underlying protocol.

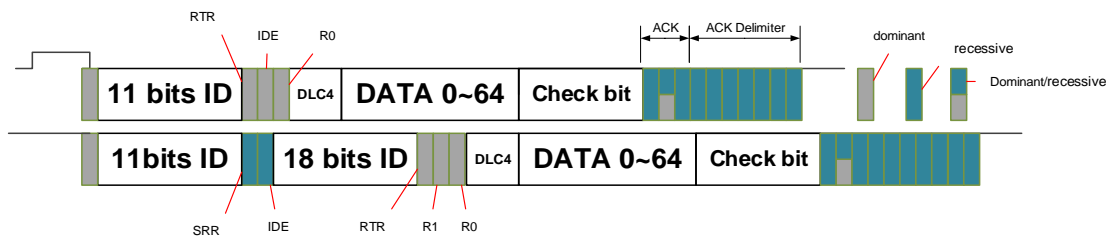

CAN trigger settings:

Press the front panel **Trig Menu** button to open the trigger function menu.

[Type] Select CAN and press V0 to confirm

[Data source] Select CH1~CH4 or LA as the trigger source.

Note: LA must be inserted when LA is used as the trigger source.

[Baud rate] Select the baud rate.

DPO6000 / MPO6000 series machines provide users with common baud rates as follows:

10000	20000	33300	50000	62500
83300	100000	125000	250000	500000
800000	1000000	Custom		

If the user does not find the required baud rate in the above table, you can select Custom and then set the required baud rate.

[Baud User] Users set their own baud rate {only available if you choose to customize this menu}

[When] Set CAN trigger conditions:

Start bit: CAN triggers at the beginning of a frame.

Remote frame ID: Triggered when the CAN frame type is remote frame, the frame ID is

received, and the ID is equal to the user set value.

Data frame ID: Triggered when the CAN frame type is a data frame, the frame ID is received, and the ID is equal to the value set by the user.

Frame ID: Triggered when CAN receives the frame ID and the ID is equal to the user set value.

Frame ID and data: CAN data reception is complete, trigger when ID and data are equal to the user set value.

Error frame: trigger when CAN error frame is detected.

All errors: error frame of CAN is detected, bit error, trigger when confirm error.

Acknowledge error: Ack error of CAN is triggered.

Overload frame: trigger when CAN overload frame is detected.

[Identifier] The identifier data when CAN is triggered.

[Data 1] Data when CAN is triggered.

[Data 2] Data when CAN is triggered

[Data 3] Data when CAN is triggered

[Data 4] Data when CAN is triggered

[Idle level] The level value (level / high level) during the CAN frame interval. The default setting is: low level.

[Mode] Select the acquisition mode (auto, normal) and press V0 to confirm.

[Holdoff] Set the holdoff time.

[Decode] Switch the decoding function.

[Label position] The position where the decoded data is drawn on the screen (only available when the decode function is turned on).

[Table] Data recording mode.

Trigger level knob: The analog channel can modify the trigger level value. The trigger mark moves up and down with the rotation of the knob. (The digital channel can change the trigger threshold of the digital channel by setting the threshold voltage.)

Trigger setting example:

Data source: CH1; Baud rate: 1000000; When: Start bit; Idle level: High. Adjust the trigger level, the trigger result is displayed as follows:

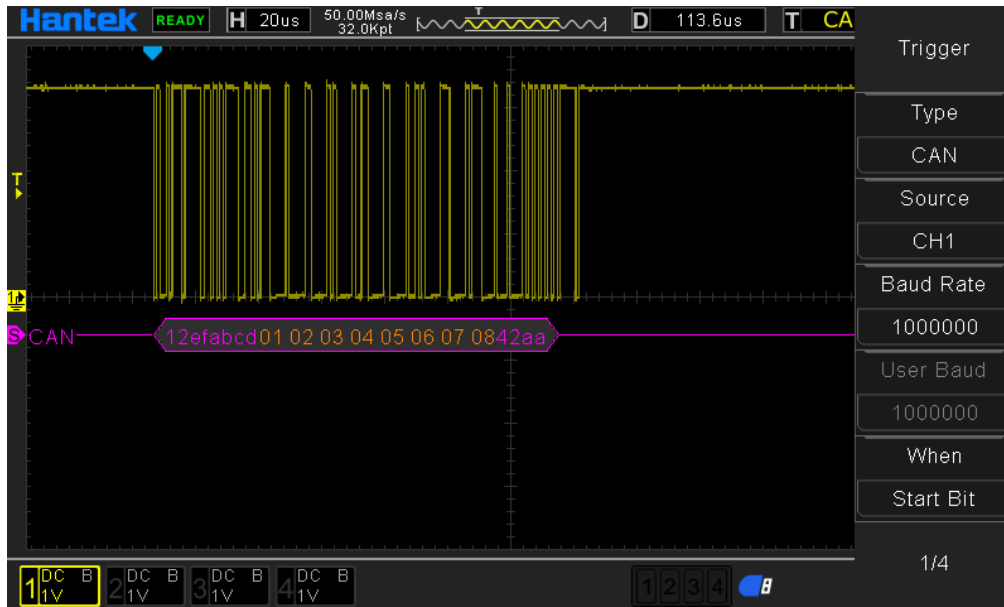

CAN decoding explanation:

1. The decoded data is displayed in hexadecimal;
2. "Frame ID" and "Check Digit" display color is purple, "Data" display color is orange;
3. When "?", "Please adjust the time base" or "Please adjust the trigger (no trigger)" appears, you need to adjust the time base or trigger to get the decoding result.

SPI trigger [optional]

SPI is the abbreviation of Serial Peripheral Interface. It is a synchronous serial interface technology introduced by Motorola. It is a high-speed, full-duplex, synchronous communication bus.

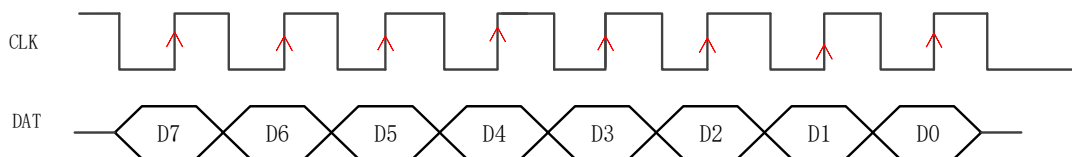

In SPI triggering, when the timeout condition is met, the oscilloscope will trigger when it finds the specified data. When using SPI triggering, you need to specify the SCL clock source and SDA data source. The timing diagram of the SPI bus is as follows:

Press the front panel **Trig Menu** button to open the trigger function menu.

[Type] Select SPI and press V0 to confirm.

[Clock Source] Select CH1~CH4 or LA as the trigger source.

Note: LA must be inserted when LA is used as the trigger source.

[Slope] Select the required triggering edge (rising edge, falling edge, double edge) and press V0 to confirm.

[Data source] Select CH1~CH4 or LA as the trigger source.

Note: LA must be inserted when LA is used as the trigger source.

[Overtime] The timeout period must be greater than the period of the CLK clock source.

Note: During data analysis, the time greater than this is used as the end condition for SPI analysis data.

[Data bit width] Set the data bit width.

[Data Bit] Set the number of data bits.

[Mode] Select the acquisition mode (auto, normal) and press V0 to confirm.

[Holdoff] Set the holdoff time.

[Decode] Switch the decoding function.

[Label position] The position where the decoded data is drawn on the screen (only available when the decode function is turned on).

[Table] Data recording mode.

Trigger level knob: The analog channel can modify the trigger level value. The trigger mark moves up and down with the rotation of the knob. (The digital channel can change the trigger threshold of the digital channel by setting the threshold voltage.)

Trigger setting example:

Clock source: CH2; Slope: Rise; Data source: CH1; Timeout:4.12us; Data length: 32; Adjust the trigger level, the trigger result is displayed as follows:

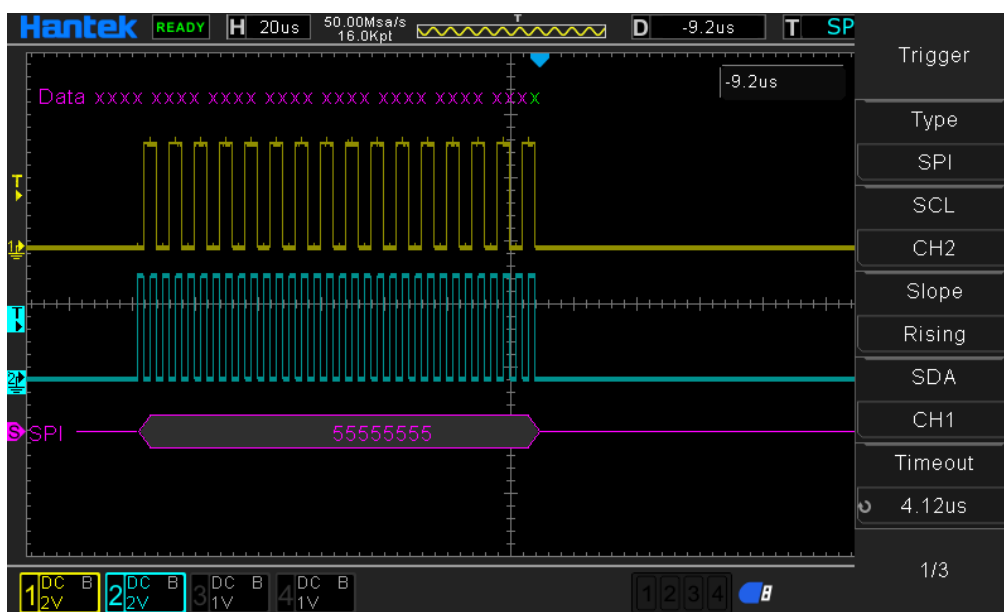

SPI decoding explanation:

1. The decoded data is displayed in hexadecimal;
2. The "Data" display color is purple;
3. When "?", "Please adjust the time base" or "Please adjust the trigger (no trigger)" appears, you need to adjust the time base or trigger to get the decoding result.

IIC trigger [optional]

IIC (Inter-Integrated Circuit BUS) integrated circuit bus. This bus is designed by NXP (formerly PHILIPS) company. It is mostly used for master-slave communication between master controller and slave devices. It is used in small data volume occasions, short transmission distance, any time there can only be one host, etc.

IIC address addressing mode is divided into 7-bit addressing mode and 10-bit addressing mode

7-bit addressing

In the 7-bit addressing process, the slave address starts to be transmitted in the first byte after the start signal. The first 7 bits of the byte are the slave address, and the 8th bit is the read and write bit, where 0 means write and 1 Means read.

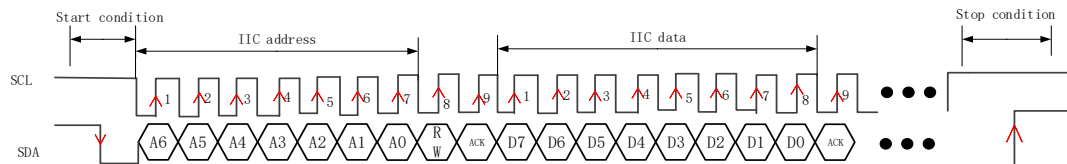

10-bit addressing

The 10-bit addressing and 7-bit addressing of the IIC bus are compatible, so that devices with 7-bit address and 10-bit address mode can be used on the same bus at the same time. When transmitting 10-bit addresses, the first byte is a special reserved address. To indicate that the 10-bit address is currently being transmitted.

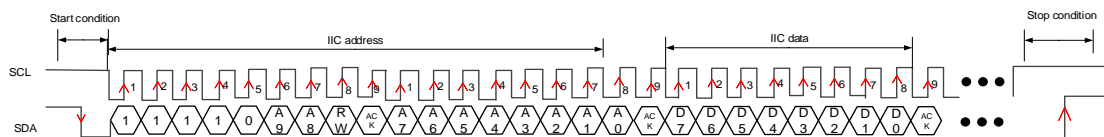

The IIC (Inter-Integrated Circuit Bus) signal settings include a serial data (SDA) line and a serial clock (SCL) line connected to an oscilloscope, and then specify the input signal threshold voltage level.

Press the front panel **Trig Menu** button to open the trigger function menu.

[Type] Select IIC and press V0 to confirm.

[Address width] Select 7 or 10 digits.

[Clock Source] Select CH1~CH4 or LA as the trigger source.

Note: LA must be inserted when LA is used as trigger source

[Data source] Select CH1~CH4 or LA as the trigger source.

Note: LA must be inserted when LA is used as trigger source

[When] Set IIC trigger conditions:

Start bit: IIC start condition detected

Stop bit: IIC stop condition detected

No response: trigger when IIC bus response level error

Address: IIC address is received, trigger when the data is equal to the user set value

Restart: triggered when a new start condition occurs before the stop condition

Address and data: Triggered when the IIC address is received and the data (4 bytes of data) is equal to the user set value.

[Address] Identifier data when IIC is triggered.

[Data 1] Data when IIC is triggered

[Data 2] Data when IIC is triggered

[Data 3] Data when IIC is triggered

[Data 4] Data when IIC is triggered

[Mode] Select the acquisition mode (auto, normal) and press V0 to confirm.

[Holdoff] Set the holdoff time.

[Decode] Switch decoding function

[Label position] The position where the decoded data is drawn on the screen (only available when the decode function is turned on).

[Table] Data recording mode

Trigger level knob: The analog channel can modify the trigger level value. The trigger mark moves up and down with the rotation of the knob. (The digital channel can change the trigger threshold of the digital channel by setting the threshold voltage.)

Trigger setting example:

Address width: 7 bits; Clock source: CH1; Data source: CH2; When: Start bit. Adjust the trigger level, the trigger result is displayed as follows:

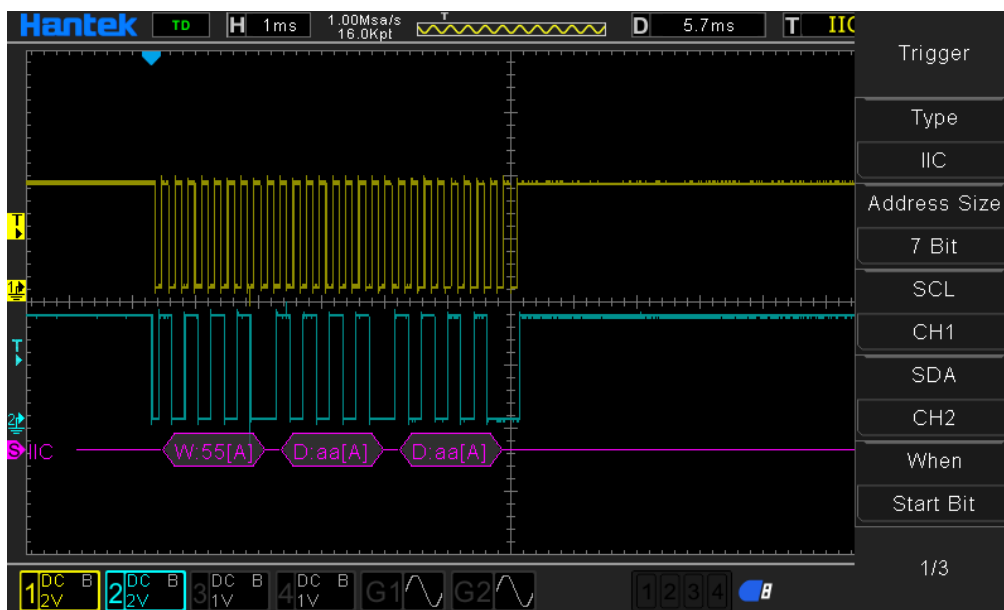

IIC decoding explanation:

1. The decoded data is displayed in hexadecimal;
2. "Address" and "Data" are displayed in purple; "W" indicates a write operation, "R" indicates a read operation, "D" indicates decoded data, and "A" means answer; "~A" means no answer;
3. When "?", "Please adjust the time base" or "Please adjust the trigger (no trigger)" appears, you need to adjust the time base or trigger to get the decoding result.

Protocol decoding

Users can easily find errors, debug hardware, and accelerate development progress through protocol analysis. DPO6000 / MPO6000 series machines provide decoding of 5 common protocols, including UART, LIN, CAN, IIC and SPI.

Note: Only when the user correctly configures the protocol trigger setting parameters can the correct decoding result be obtained.

Decoding mode

The decoding function is only available when the protocol is triggered. Turn on the decoding switch. At this time, the magenta serial decoding cursor appears on the left side of the oscilloscope (the default is at the bottom of the screen). The user can change the position of the label by selecting the label position menu. The decoded position acquisition waveform has a better display position for users to analyze the decoded data.

Table mode

The table function can only be used when the protocol is triggered. When the table mode is enabled, the oscilloscope does not perform waveform data acquisition and display when the oscilloscope is running in the table mode. It only displays the correct protocol decoded data. The decoded data is transmitted to the screen in real time. When the oscilloscope is running in table mode, only F1, F2, F3, RUN / Stop soft keys can be used, and other keys cannot be used. If the user needs to set other parameters of the serial port, he needs to exit table mode. After the user pauses, the decoded data can be exported for analysis.

Mathematics

Addition

The waveform values of data source 1 and data source 2 are added point by point and the result is displayed.

Steps:

1. Press the **Math** button on the front panel to enter the MATH function menu. Turn the multi-function knob V0 to select "+" for addition operation.
2. Press the [Data Source 1] and [Data Source 2] soft keys and turn the multi-function knob V0 to select the data source. 4 analog channels can be used as data sources. The resulting math waveform is displayed on the screen and labeled "M".
3. Operation waveform settings:

[Offset]: Set the vertical offset of the operation waveform relative to the time axis;

[Scale]: Set the unit volt value in the vertical direction.

The setting of the operation waveform in the horizontal direction is the same as that of the data source waveform.

[Setting] is not available at this time.

Subtraction

Subtract the waveform values of data source 1 and data point by point and display the result.

The operation steps are the same as those of [Addition].

Multiplication

Multiply the waveforms of data source 1 and data source 2 point by point and display the result.

The operation steps are the same as those of [Addition].

The units of the calculation waveform "offset" and "scale" are user-defined (represented by U).

Division

Divide the waveform of data source 1 and data source point by point and display the result. It can be used to analyze the multiple relationships between the waveforms of two channels.

The operation steps are the same as those of [Addition].

Note: When the voltage value of data source 2 is zero, the operation result is treated as invalid.

The units of the calculation waveform "offset" and "scale" are user-defined (represented by U).

FFT

FFT uses the analog input channel waveform to calculate a fast Fourier transform. The FFT operation can be used to convert a time domain (YT) signal into its frequency components (spectrum), showing the relationship between dB V and frequency. The horizontal axis reads from time to frequency (Hz) and the vertical reads from V to dB. FFT operations can be used for the following tasks:

- ◆ Measure harmonic content and distortion in the system
- ◆ Represents noise characteristics in DC power supply
- ◆ Analysis of vibration

Steps:

1. Press the **Math** button on the front panel to open the Math function menu. Turn the multi-function knob V0 to select "FFT" for fast Fourier transform operation.
2. Press the [Data Source] soft key and turn the multi-function knob V0 to select a data source. 4 analog channels can be used as data sources. The resulting math waveform is displayed on the screen and labeled "M".
3. Operation waveform settings:

[Center]: Set the frequency of the frequency domain waveform corresponding to the

horizontal center of the screen.

[Span]: Set the horizontal scale of the FFT waveform.

[Reference level]: Set the reference level of the FFT waveform.

[Scale]: Set the unit volt value in the vertical direction.

[Vertical Unit]: Select the unit of the vertical axis. The units of the vertical axis can use the logarithmic scale to display the vertical amplitude in dB or the linear scale to display the vertical amplitude in Vrms.

[Window]: Select the appropriate window.

When window functions are used, spectral leakage can be greatly reduced. This series of oscilloscopes provide FFT window functions with 6 different characteristics, which are suitable for measuring different waveforms. Users can select window functions based on different waveforms and their characteristics.

Window	Measurement	Characteristics
Rectangular	Transient or short pulse waveform	Dedicated window for discrete window similar to the situation when no window is multiplied
Hanning	Period waveform	Better frequency resolution Poorer amplitude resolution
Hamming	Transient or short pulse waveform	A little bit better frequency resolution than Hanning.
Blackman	Single frequency signal, search for higher order harmonics	The best amplitude resolution; the poorest frequency resolution
Bartlett (Triangle)	Stronger narrow band signal	Better frequency resolution
Flattop	Period waveform	Better amplitude resolution Poorer frequency resolution

[Show-Only]: Set whether to display only the FFT calculation result and not the data source waveform.

[Auto Scale]: The system can automatically set to the best display state of the FFT waveform.

Note:

1. Signals with DC components or deviations can cause errors or deviations in the FFT waveform components. In order to reduce the DC component, the channel coupling of the data source can be set to "AC" mode.
2. To reduce the random noise and aliasing frequency components of repetitive or single pulse events, set the [Acquisition Mode] of the oscilloscope to "Average".

Measure FFT waveform with cursor

To perform cursor measurement, first press \square Cursors on the front panel of the oscilloscope to turn on cursor measurement. Press the [Mode] soft key to select manual or tracking. Use AX and BX cursors to measure the frequency and the difference between the two frequencies (BX-AX). Use AY and BY cursors to measure amplitude and amplitude difference (BY-AY).

Integral

Calculate the points for the specified data source. For example, you can use integrals to calculate the energy of a pulse or measure the area under a waveform.

The operation steps are the same as those of the [Addition] operation, and the integral operation is performed on a single data source.

The units of the calculation waveform "offset" and "scale" are user-defined (represented by U).

Differential

Calculates the discrete-time derivative of the specified data source. For example, a differential can be used to calculate the instantaneous slope of a waveform.

The operation steps are the same as those of the [Addition] operation, and a differential operation is performed on a single data source.

[Setting]: Set the single-step value of differential operation waveform display.

The units of the calculation waveform "offset" and "scale" are user-defined (represented by U).

Square root

Calculates the square root of the specified data source waveform point by point and displays the result.

The operation steps are the same as those of the [Addition] operation. The square root operation is performed on a single data source.

The units of the calculation waveform "offset" and "scale" are user-defined (represented by U).

Expression

User-defined operation expressions of any one or more analog channel waveforms of CH1-CH4.

Math waveform settings:

[Offset]: Set the vertical offset of the operation waveform relative to the time axis;

[Scale]: Set the unit volt value in the vertical direction.

The setting of the operation waveform in the horizontal direction is the same as that of the data source waveform.

[Setting]: Edit the operation expression and set the data source waveform single step value and threshold.

The units of the calculation waveform "offset" and "scale" are user-defined (represented by U).

The expressions available for "editing" are shown below.

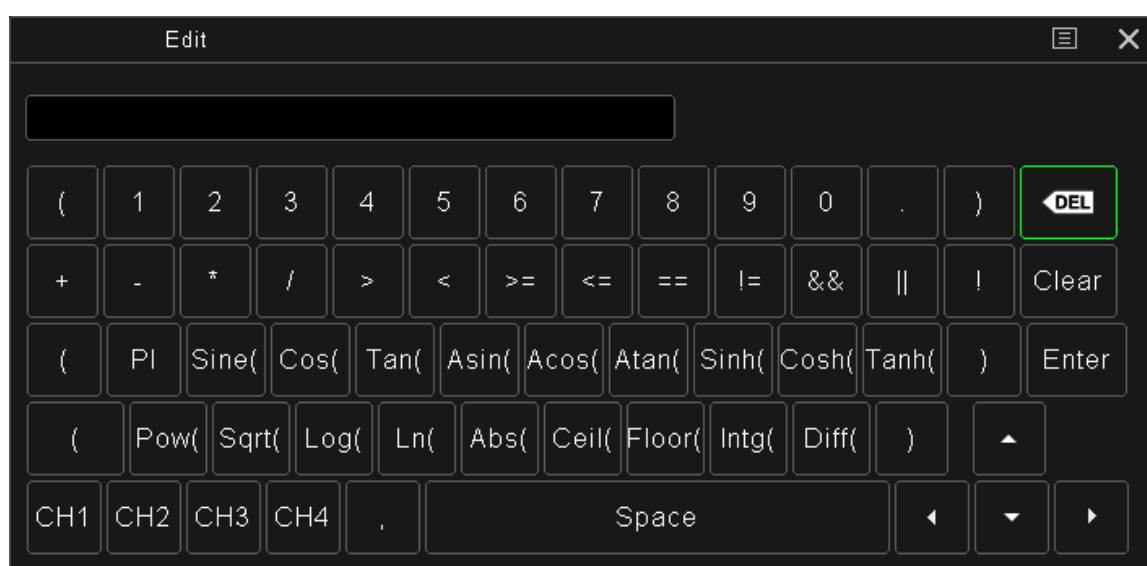

Measurement

Measurement parameter description

DPO6000 / MPO6000 series oscilloscopes provide automatic measurement of 42 kinds of waveform parameters, and statistics and analysis functions of measurement results. In addition, users can also use the digital multimeter [DVM] to achieve more accurate frequency measurement. Before performing the measurement operation, please understand these 42 waveform parameters in detail.

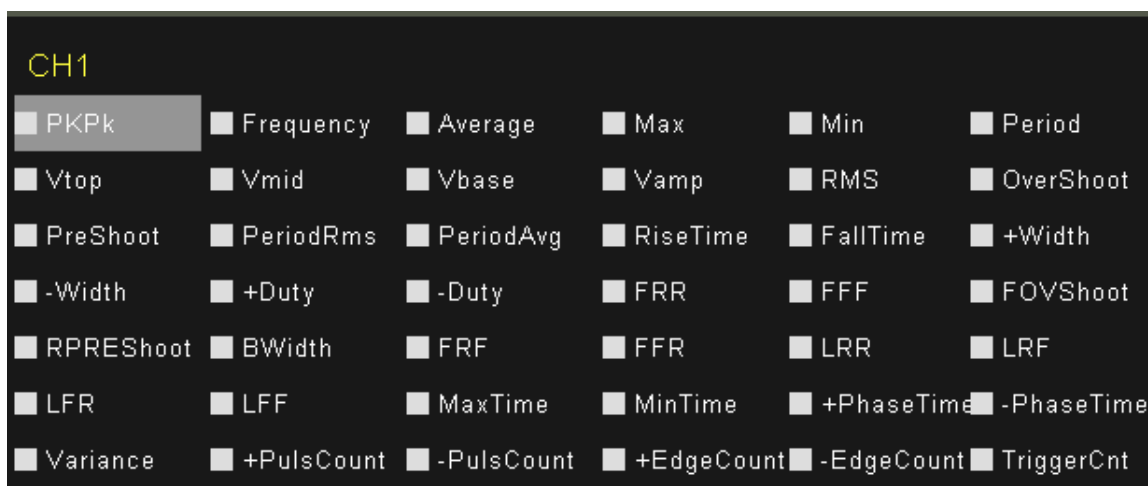

Time parameter

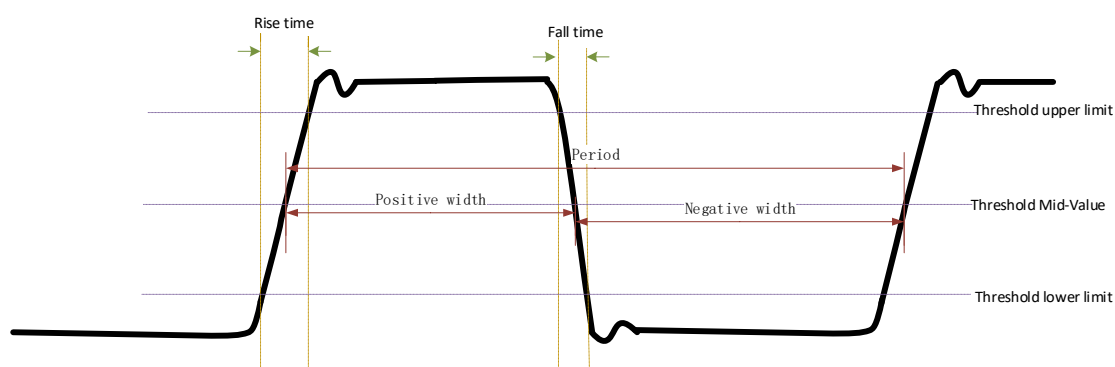

1. Period [P_k-P_k]: Defined as the time between the middle threshold crossing points of two consecutive, same-polarity edges.
2. Frequency: Defined as the reciprocal of the period.
3. Rise Time: The time it takes for the signal amplitude to rise from the lower threshold to the upper threshold.
4. Fall Time: The time it takes for the signal amplitude to fall from the upper threshold value to the lower threshold value.
5. Positive pulse width [+ Width]: The time difference from the middle value of the threshold of the rising edge of the pulse to the middle value of the threshold of the next falling edge.
6. Negative pulse width [-Width]: The time difference from the threshold intermediate value of the falling edge of the pulse to the threshold intermediate value of the next rising edge.
7. Positive Duty Cycle [+ Duty]: The ratio of positive pulse width to period.

$$+Duty = \frac{\text{positive pulse}}{\text{period}} \times 100\%$$

8. Negative Duty Cycle [-Duty]: The ratio of negative pulse width to period.

$$-Duty = \frac{\text{negative pulse}}{\text{period}} \times 100\%$$

9. Burst Length [B-Width]: The time from the first edge of the data source to the last edge of the data source.

10. Maximum time [V_{\max} Time]: The time value corresponding to the maximum value (V_{\max}) of the waveform.

11. Minimum time [V_{\min} Time]: The time value corresponding to the minimum value (V_{\min}) of the waveform.

Note: The upper threshold, middle threshold, and lower threshold are 90%, 50%, and 10%, respectively.

Count value parameters

1. Positive Pulse Count [+ Pulse Count]: The number of positive pulses rising from below the lower threshold to above the upper threshold.

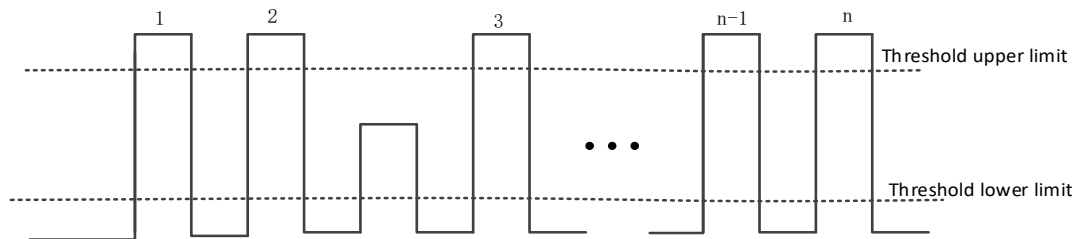

2. Negative pulse number [- Pulse Count]: the number of negative pulses from above the upper threshold to below the lower threshold.

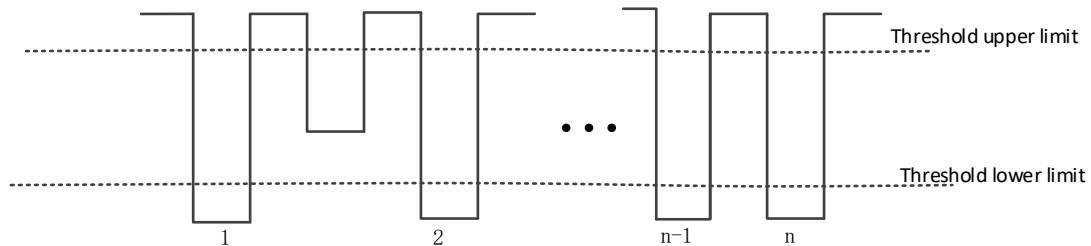

3. Rise Pulse Count: The number of rising edges rising from below the lower threshold to above the upper threshold.

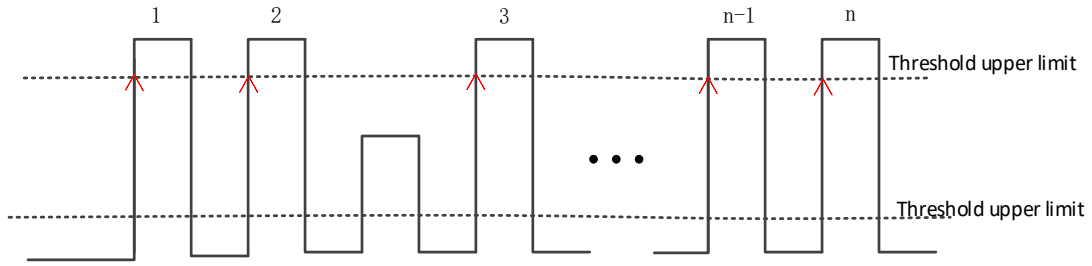

4. Fall Pulse Count: The number of falling edges from the upper threshold to the lower threshold.

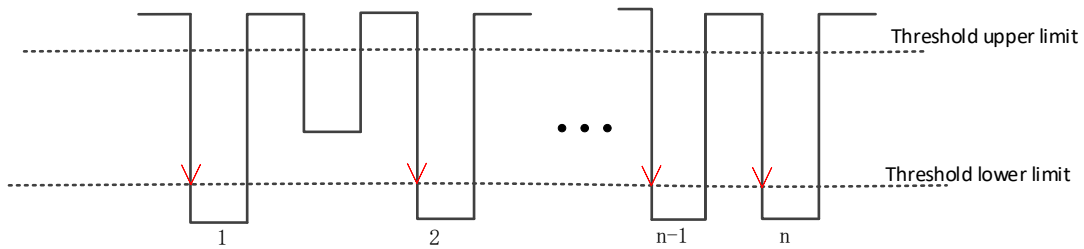

5. Trigger Count: The number of rising (or falling) edges from the threshold.

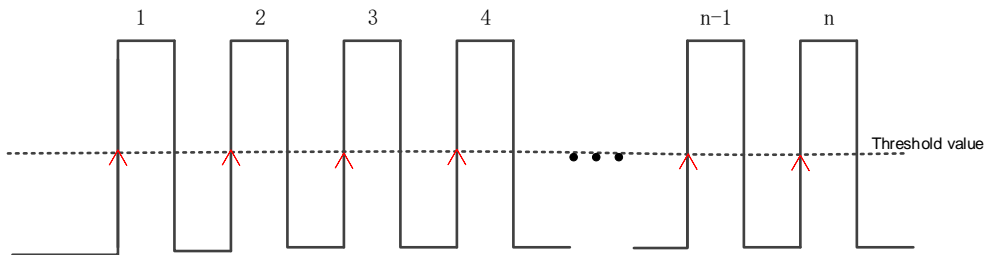

Note: The above measurement items are only applicable to analog channels. The default values for the upper and lower thresholds are 90% and 10%, respectively.

Delay and phase parameters

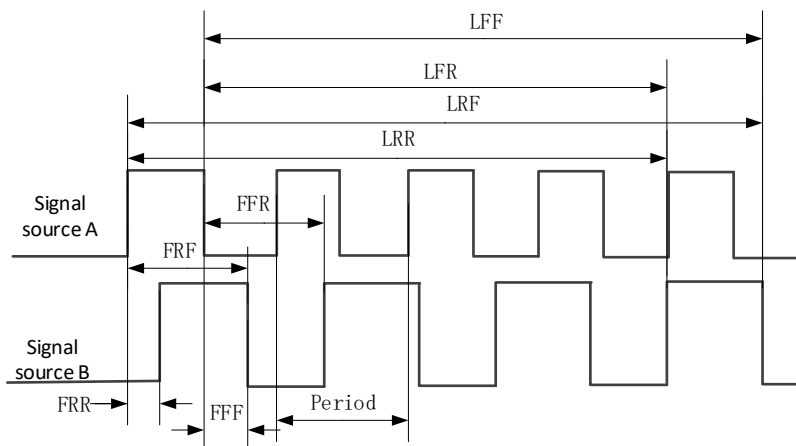

Data source A and data source B, that is, data source A and data source B in the measurement setting menu, can be any channel from CH1-CH4 or D0-D15, please refer to the description in "Measurement Settings" for setting.

1. FRR [First Delay Rise-Rise]: $\uparrow A \rightarrow \uparrow B$, the time difference between the first rising edge of data source A and data source B.
2. FFF [First Delay Fall-Fall]: $\downarrow A \rightarrow \downarrow B$, the time difference between the first falling edge of data source A and data source B.
3. FRF [First Delay Rise Fall]: $\uparrow A \rightarrow \downarrow B$, the time difference between the first rising edge of data source A and the first falling edge of data source B.
4. FFR [First Delay Fall Rise]: $\downarrow A \rightarrow \uparrow B$, the time difference between the first falling edge of data source A and the first rising and falling edge of data source B.
5. LRR: [Last Delay Rise-Rise]: $\uparrow A \rightarrow \uparrow B$, the time between the first rising edge of data source A and the last rising edge of data source B.
6. LRF [Last Delay Rise Fall]: $\uparrow A \rightarrow \downarrow B$, the time between the first rising edge of data source A and the last falling edge of data source B.
7. LFR [Last Delay Fall Rise]: $\downarrow A \rightarrow \uparrow B$, the time between the first falling edge of data source A and the last rising edge of data source B.
8. LFF [Last Delay Fall-Fall]: $\downarrow A \rightarrow \downarrow B$, the time between the first falling edge of data source A and the last falling edge of data source B.
9. Phase [Phase Rise Time]: $\uparrow A \rightarrow B$, the phase difference calculated according to "Delay 1- \rightarrow 2" and the period of data source 1, expressed in degrees.
10. Phase [Phase Fall Time]: $\downarrow A \rightarrow B$, the phase difference calculated according to "Delay 1- \rightarrow 2" and the period of data source 1, expressed in degrees.

The calculation formula of the phase is:

$$\text{Phase} = \frac{\text{Delay}}{\text{period1}} \times 360^\circ$$

Among them,

Phase means "phase $\uparrow A \rightarrow B$ " or "phase $\downarrow A \rightarrow B$ "

Delay means "Delay FRR" or "Delay FFF"

Period1 represents the period of digital data source source 1.

Voltage parameters

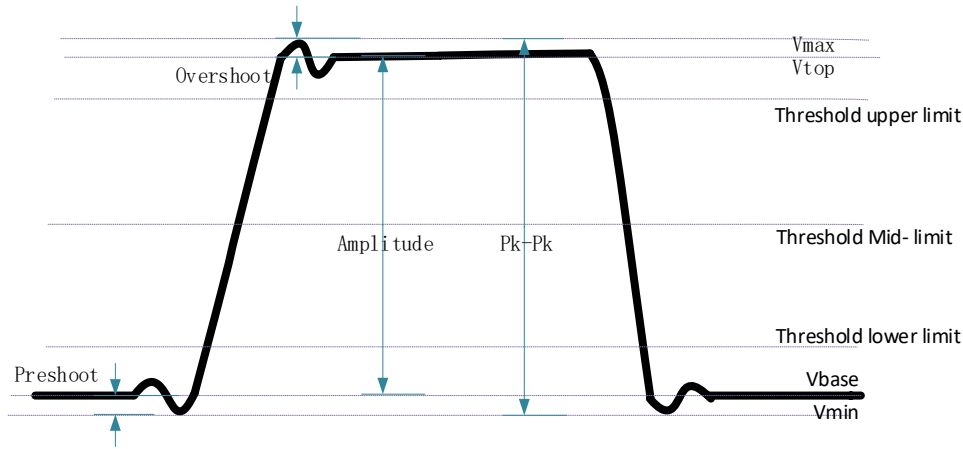

1. Maximum [V_{\max}]: The voltage value from the highest point of the waveform to GND.
2. Minimum [V_{\min}]: The voltage value from the lowest point of the waveform to GND.
3. Double peak [P_k-P_k]: The voltage value from the highest point to the lowest point of the waveform.

$$\text{Double peak} = \text{Maximum} - \text{Minimum}$$

4. Top value [V_{top}]: The voltage value from the flat top of the waveform to GND.
5. Bottom value [V_{base}]: The voltage value from the flat bottom of the waveform to GND.
6. Amplitude [V_{amp}]: The voltage value from the top to the bottom of the waveform.

$$\text{Amplitude} = \text{Top value} - \text{Low value}$$

7. Middle value [V_{mid}]: The actual voltage value corresponding to the middle value of the measurement threshold.
8. Average: Arithmetic average over the entire waveform or gated area.
9. Period average: The arithmetic average of the first period of the waveform.

$$\text{Average} = \frac{\sum x_i}{n}$$

Among them, x_i is the measurement result of the i -th point, and n is the number of measured points.

10. Root Mean Square [V_{rms}]: The root mean square value over the entire waveform or gated area.
11. Root-Mean-Square [Per- V_{rms}]: Root mean square value in one cycle.

$$\text{RMS} = \sqrt{\frac{\sum_{i=1}^n x_i^2}{n}}$$

Among them, x_i is the measurement result of the i -th point, and n is the number of measured points.

12. Overshoot: The ratio of the difference between the maximum value of the waveform and the top value to the amplitude.

13. Pre-shoot: The ratio of the difference between the minimum value and the bottom value of the waveform to the amplitude.

14. Fall Overshoot: The ratio of the difference between the maximum value and the top value of the waveform to the amplitude.

15. Rise Pre-shoot: The ratio of the difference between the minimum value of the waveform and the bottom value to the amplitude.

16. Variance: The average of the sum of the squares of the difference between the amplitude value of each waveform point and the average value of the waveform over the entire waveform or gated area. The variance reflects the degree of fluctuation of the waveform. Calculated as follows:

$$\text{Variance} = \frac{\sum_{i=1}^n (V_{amp}(i) - \text{Average})^2}{n}$$

Among them, $V_{amp}(i)$ is the amplitude value of the i -th point, Average is the average value of the waveform, and n is the number of measured points.

All measurements

Press **Meas** on the front panel to enter the measurement setting interface. Press **[All Measurements]** to measure 42 waveform parameters with one key. The measurement results are displayed at the bottom of the screen, and the color markers consistent with the current measurement channel are displayed.

Note: If the measurement display is "****", it means that the current measurement source has no signal input, or the measurement result is not within the valid range (too large or too small).

[Setting]: Set the data source A and data source B to perform the measurement of "Delay and Phase Parameters".

[Gating]: User-defined measurement range, indicated by cursor A and cursor B.

Measurement statistics

Statistic and display the current value, average value, maximum value, minimum value,

root mean square error and count value of the waveform parameters of the selected data source.

Press **[Type]** and turn the multi-function knob V0 to select the waveform parameters to perform measurement statistics.

Waveform parameters of measurement statistics can be displayed 4 kinds at a time, and more than 4 kinds of waveform parameters will be covered and updated from bottom to top.

	cur	avg	max	min	rmse	count
Freq	1KHz	1KHz	1KHz	1KHz	0.00Hz	4208
VRms	1.38V	1.37V	1.58V	0.00V	177.98mV	4035
PDuty	0.5%	0.5%	0.5%	0.5%	0%	3876
TriggerCnt	2	1	2	1	0	3749

[Clear all]: Clear all measurement data on the current display, including measurement results, statistical results, and gate control.

Digital Voltmeter (DVM)

DPO6000 / MPO6000 series oscilloscopes have built-in digital voltmeter (DVM) and frequency meter, which can measure the voltage and frequency of analog channels, and monitor the signal when the oscilloscope is running or stopped, which can improve the user's counting and frequency measurement experience.

DVM performs 5-digit AC RMS, DC, AC + DC RMS voltage measurements and 6-digit frequency measurements.

Press **[Meas]**-> Digital Voltmeter-> Enable on the front panel to turn on the digital voltmeter;

[Data source] Select the data source to be tested.

[Type] Select the type of digital voltmeter display.

When DVM measurement is turned on, the display is as shown below. The DVM display results include the range. The range of the range is determined by the vertical scale and vertical offset of the channel. The range is the screen range. The upper specific value is the measurement result, the middle is the range, and the lower is the frequency of the measurement.



Grid scale measurement

Grid scale measurement: This method can be used to quickly and intuitively estimate the frequency and voltage amplitude of the waveform. It can be easily measured by the division of the grid and the scale factor.

For example, a simple measurement can be made by calculating the relevant major and minor scale divisions and multiplying by the scale factor. If it is calculated that there are 6 major vertical scale divisions between the maximum and minimum values of the waveform, and the known scaling factor is 50mV/division, the peak-to-peak voltage can be calculated as follows:

$$6 \text{ divisions} \times 50\text{mV/division} = 300\text{mV}$$

Automatic measurement

Quick measurement after AUTO

After connecting the oscilloscope correctly, input a valid signal, press the **Auto Scale** key to automatically set the waveform and open the following function menu:

Single cycle: Set the screen to display the signal of a single cycle automatically. At the same time, a single cycle of "time parameter" and "voltage parameter" measurement is performed on the current data source, and the measurement result is displayed at the bottom of the screen.

Multi-cycle: Set the screen to automatically display signals for multiple cycles. At the same time, multi-cycle "time parameter" and "voltage parameter" measurements are performed on the current data source, and the measurement results are displayed at the bottom of the screen.

Auto range: Select the scale automatically set by the system: "horizontal and vertical scale", "horizontal scale" or "vertical scale".

Data source: Set the channel to be set automatically: "Display only", "All". Display only: After the system performs the automatic setting, only the waveform of the opened channel with signal input is displayed; all: After the system performs the automatic setting, the waveforms of all channels with signal input are displayed.

Cursor measurement

Cursor measurement is performed by moving the cursor. The cursors always appear in pairs, and the displayed reading is the measured value. There are two types of cursors: amplitude and time cursors.

Amplitude cursor: The amplitude cursor is displayed as a horizontal dashed line and is used to measure parameters in the vertical direction.

Time cursor: The time cursor is displayed as a vertical dashed line and is used to measure parameters in the horizontal direction.

There are two methods for cursor measurement: manual and tracking.

1. Manual

The horizontal cursor or vertical cursor appears in pairs to measure time and voltage. The cursor position can be adjusted manually. When using the cursor, be sure to set the Data Source to the waveform you want to measure on the display.

2. Tracking

The horizontal cursor intersects with the vertical cursor to form a cross cursor. The cross cursor is automatically positioned on the waveform. The horizontal position of the cross cursor on the waveform can be adjusted by selecting "Source A" or "Source B" and turning the V0 knob. The coordinates of the cursor cross point will be displayed on the oscilloscope screen.

Press the **Cursors** button to enter the cursor menu.

Option	Setting	Comments
Mode	Manual	Select a measurement cursor and display it.
	Tracking	
Data source	CH1~CH4 MATH	Selects a data source for cursor measurement.
Select cursor	AX(BX)	The highlighted cursor selected by AYBY can be moved freely. You can select two cursors and move them simultaneously. The box behind the cursor shows the position of the cursor.
	AXBX	
	AY(BY)	
	AYBY	

Move Cursor: Select the cursor type and turn the multi-function knob V0 to move the cursor. The cursor can only be moved when the cursor menu is open.

Bode plots (signal source series)

The Bode plots are a semi-logarithmic plot of the transfer function versus frequency of a linear non-time-varying system. The horizontal axis is frequency and the vertical axis is expressed on a log scale. The frequency response of the system can be seen using

the Bode plot. The Bode plots are generally composed of two diagrams. One amplitude-frequency diagram represents the change in the decibel value of the frequency response gain versus frequency, and the other phase-frequency diagram represents the change in phase versus frequency of the frequency response.

The figure of the Bode plots is related to the system's gain, the number of poles and zeroes, and the position. As long as the relevant information is known, an approximate Bode plot can be drawn with simple calculations. This is the advantage of using a Bode plots.

Bode plots brief

The Bode plots is also called the amplitude frequency response and phase frequency response curve, which is generally the rectangular coordinate of the amplitude and phase at the fundamental frequency of the rotating machine relative to the rotor speed.

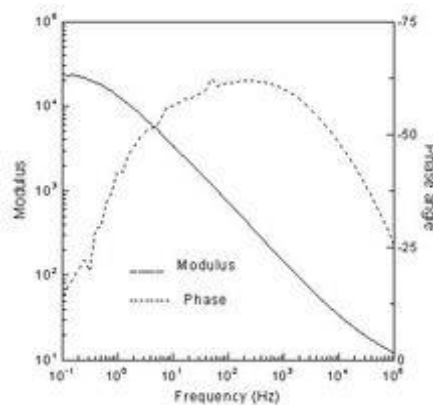

Bode plots

The logarithmic frequency characteristics are drawn using the method of polyline approximation when drawing. General drawing of Bode plots:

When drawing a Bode plots, it is performed in three frequency bands. The amplitude-frequency characteristics are drawn first, in the order of mid-band, low-band, and high-band. The frequency characteristics (or frequency response) of the three frequency bands together are the amplitude-frequency characteristics of the entire frequency band, and then the corresponding phase-frequency characteristics are drawn according to the amplitude-frequency characteristics.

Application of Bode plots

When studying the frequency response of the amplifier circuit, because the frequency range of the signal is very wide (from a few hertz to several hundred megahertz or more), the amplification factor of the amplifier circuit is also very large (up to one million times). It is a compressed coordinate to expand the field of view when drawing the frequency characteristic curve, the frequency coordinates are exponentially scaled, and

the amplitude (in dB) or phase angle is logarithmic. The amplitude-frequency and phase-frequency curves drawn in such semi-logarithmic coordinates are called log-frequency characteristics or Bode plots.

The Bode plots contain both new (blue) data and old (green) data. The "sampling noise" in traditional systems can be seen in the plot.

When analyzing the stability of negative feedback amplifier circuits in the course of analog electronic technology, colleges and universities generally use the Bode plot analysis method.

Enable Bode plots

Press the front-panel **Utility**-> Bode Plots -> Function [On, Off].

Bode plots data source settings

Press the front-panel **Utility**-> Bode Plots-> Settings-> Input Source. The input source can be set from CH1 to CH4.

Press **Utility**-> Bode Plots -> Settings-> Output Source on the front panel. The output source can be set to CH1~CH4.

Note:

Input sources and output sources are mutually exclusive.

The minimum frequency is 100HZ.

The maximum frequency is 25MHZ.

The amplitude is 10mV~7V.

Bode plots chart settings

Press **Utility**-> Bode Plots-> Graph on the front panel.

Gain gear-> Set the grid step value of the gain.

Gain Offset-> Set the grid center value of the gain.

Phase scale-> Set the grid step value of the phase.

Phase Offset-> Set the grid center value of the phase.

Bode plots operation

Press the front panel **Utility**-> Bode plots-> Run.

Digital channel

The MPO6000 series has 4 analog channels and 16 digital channels; DPO6000 series oscilloscopes can be upgraded to use 16-channel digital channels by purchasing the LP104 digital probe. For digital channels, the oscilloscope compares the voltage from each sample to a preset logic threshold. If the voltage at the sampling point is greater than the threshold, it is stored as logic 1; otherwise, it is stored as logic 0. The oscilloscope visually displays logic 1 and logic 0 in a graphical manner, which is convenient for users to detect and analyze errors in circuit design (hardware design and software design). This chapter describes how to use the digital channels of a mixed-signal digital oscilloscope. Before using the digital channel, please use the PL104 logic probe provided in the accessory to connect the oscilloscope and the device under test. The digital channel input interface supports hot plugging [plug and play]. And the plug-in interface is non-directional to facilitate users to access the digital probe more.

Select digital channel

Press **Utility**-> Logic Analyzer-> Data Source [D1, D2, D3, D4] on the front panel.

Enable digital channels

Connect the digital probe, the logic analyzer enable switch is automatically turned on, and the corresponding digital channel at the bottom of the screen is displayed in blue, indicating that it is connected. At the same time, the channel indicator on the logic probe lights up.

Note: The digital channel must not be left floating. You can only enable the digital channel after connecting it to the logic analyzer probe.

For digital channel input, refer to the description of channel input in the "Technical Specifications" section of this article.

Note: The number of digital channels and analog channels must not be more than 4 at the same time; otherwise "Cannot open channels" is displayed.

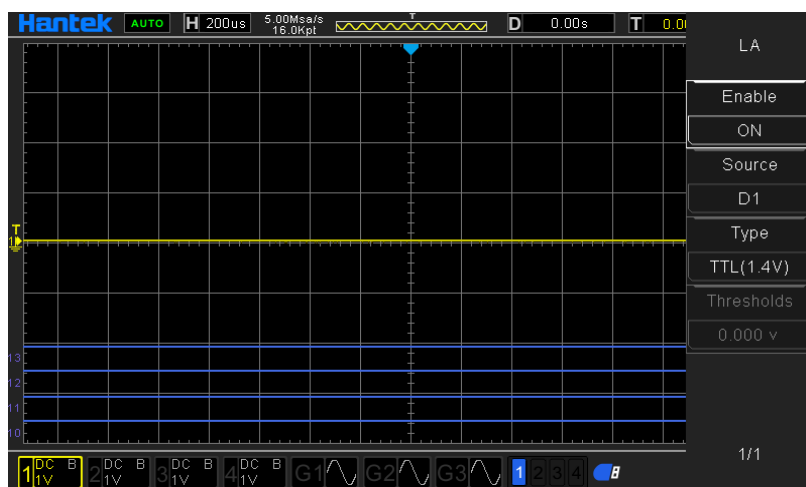

Set the digital channel thresholds type

Press the front panel **Utility**-> Logic Analyzer-> Type [TTL (1.4 V)]

5.0 V CMOS (+2.5 V)

3.3 V CMOS (+1.65 V)

2.5 V CMOS (+1.25 V)

1.8 V CMOS (+0.9 V)

ECL (-1.3 V)

PECL (+3.7 V)

LVDS (+1.2 V)

0V

User-defined [-7V~7V].

Waveform generator

The DPO6000C / MPO6000D has two built-in channels (MPO6000EDU has three built-in channels) and a 25 MHz signal source. The signal source and oscilloscope are combined into one, which greatly facilitates engineers who need to use the signal source and oscilloscope at the same time. Built-in arbitrary waveform generator can output sine, square wave, pulse, triangle wave, noise, DC, sampling wave, exponent, semi-distortion, Lorentz, dual-tone multi-frequency, Gauss, ECG signal 13 kinds of basic signals, 4 groups of arbitrary waves. Users can edit and load arbitrary waveforms through

Wave Editor Software.

This chapter explains how to use the signal source built into the oscilloscope. Since the functions and setting methods of the two / three channels of the signal source are the same, this chapter uses signal source 1 as an example.

Press the button or click the **WaveGen** area on the screen to enter the source control menu:

Output basic waveform

1. Select waveform

Push the front panel **WaveGen**-> Waveform.

2. Data source

Press **WaveGen**-> Data Source on the front panel.

3. Signal source channel

Press the front panel **WaveGen**-> Enable.

4. Frequency

Press **WaveGen**-> Frequency on the front panel.

5. Amplitude

Press the front panel **WaveGen**-> Amplitude.

Press the Amplitude soft key to set the amplitude of the current signal. When "Impedance" is set to high impedance, the range can be set from 10mVpp to 7Vpp; when "Impedance" is set to 50Ω, the range can be set from 5mVpp to 3.5Vpp.

6. Offset voltage

Press **WaveGen**-> Offset on the front panel.

Note: When "Impedance" is set to high impedance, the settable range is $(-3.5\text{ V} + \text{the currently set amplitude value} / 2)$ to $(3.5\text{ V} - \text{the currently set amplitude value} / 2)$; when "Impedance" is set to 50Ω, you can set the range from $(-1.75\text{ V} + \text{the currently set amplitude value} / 2)$ to $(1.75\text{ V} - \text{the currently set amplitude value} / 2)$.

7. Set the phase

Press **WaveGen**-> Phase on the front panel.

The adjustable range is 0 ° to 360 °.

8. Set the load impedance

Press the front panel **WaveGen**-> Load Impedance.

Load impedance can set the load input impedance of the signal source. You can choose "High impedance" or "50Ω".

9. Align phase

Press **WaveGen** -> Align phase on the front panel.

After pressing "Align phase", the signal source channel will be reconfigured so that it will output according to the set frequency and phase. For two signals with the same frequency or multiples, this operation can align their phases.

10. Modulation

Press the front panel **WaveGen** -> Modulation

For specific introduction to the modulation function, please refer to the section "[Modulation](#)".

11. Burst

Press the front panel **WaveGen** -> Burst

For a detailed introduction to the burst function, please refer to the "[Burst](#)" section.

12. Duty

The duty is used only for square waves, and represents the amount of time the waveform is high during each cycle. It is 0.001% -99.996% at low frequencies and the range will be reduced at higher frequencies.

13. Impedance

Impedance applies only to triangle waves, meaning that the triangle wave is the amount of time to rise in each cycle.

14. Pulse width

Set the pulse width.

15. Pulse leading/trailing

Set the leading and trailing edges of the pulse wave.

Edit arbitrary waveform

Edit the arbitrary waveform in the oscilloscope's waveform generator interface. First, double-click "Wave Editor Setup.exe" in the waveform editor folder on the CD-ROM and install the arbitrary waveform editor according to the installation wizard. After successful installation, the "WaveEditor" icon can be seen on the computer desktop. Double-click the icon to enter the arbitrary waveform editing window.

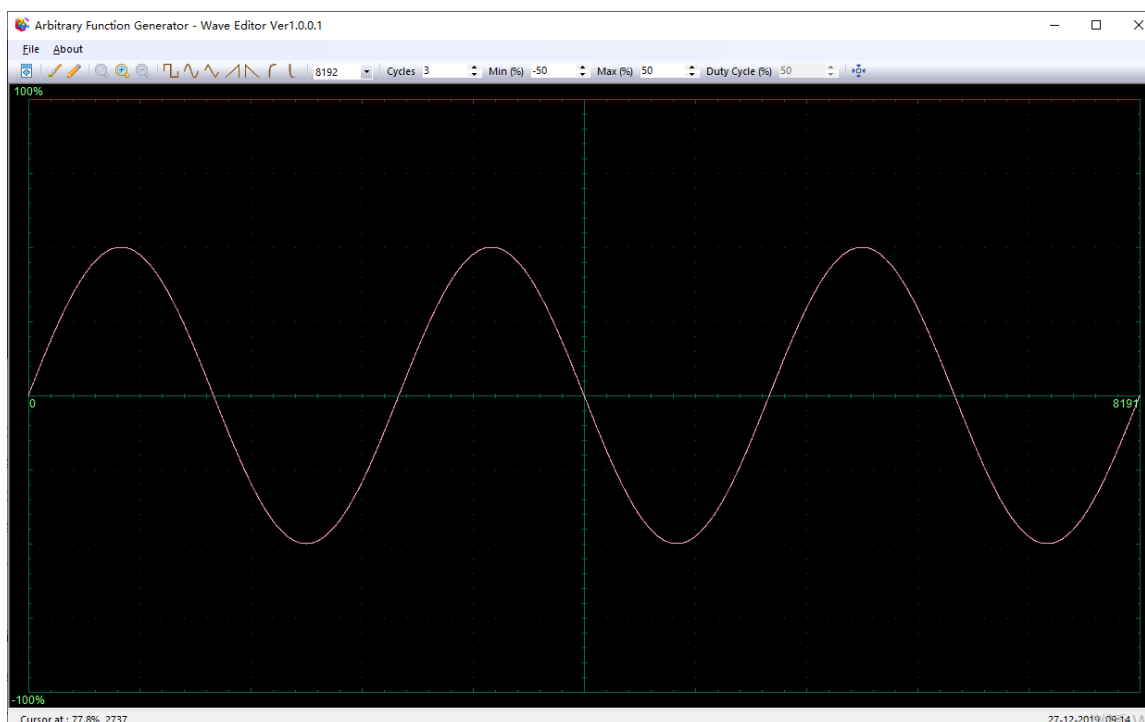

Menu:

Import from CSV file: Import CSV file to the arbitrary waveform editor interface.

Export as CSV file: Save the waveform data as a CSV file.

Import from ARB file: Import ARB file to the arbitrary waveform editor interface.

Export as ARB file: Save the waveform data as an ARB file.

Note: The device can recall the ARB file saved to the USB flash drive, but the CSV file cannot be recalled.

Toolbar button



: Download the waveform data to the device.



: Smooth drawing mode. Use the left mouse button to draw an arbitrary shape waveform.



: Linear drawing mode. Click on the waveform to draw a straight line from the previous point.



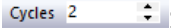

: Zoom tool. Zoom in or out of the timeline. Click the “+” or “-” zoom button, and then click the waveform area. Click the 100% button to restore the timeline to its original scale.

: Standard waveform shape. Use the numeric controls below the toolbar to draw standard waveforms according to the specified settings.

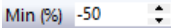
: Number of cycles. The number of waveform cycles. This control is used in conjunction with standard waveform shape buttons. Select a standard waveform, and then set the number of cycles to draw the waveform with the required number of cycles.

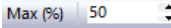
: Minimum value. This control sets the minimum signal level when the standard waveform shape button is pressed.

: Maximum value. This control sets the maximum signal level when the standard waveform shape button is pressed.



: Duty. This control sets the signal's duty when using the standard waveform shape buttons to select square, triangle, or oblique. Duty is defined as the time the signal is above zero volts divided by the total cycle time. Therefore, a symmetric square or triangular wave has a 50% duty. Reducing the duty shortens the positive part of the cycle and lengthens the negative part.

Note: When using the waveform editor software, the frequency, amplitude, and offset of the arbitrary waveform cannot be adjusted, but after the waveform data is downloaded to the device, you can directly set and adjust the device.

Do not use the waveform editor and oscilloscope software at the same time, otherwise it will cause errors.

Output arbitrary wave

Output arbitrary waveform

1. Press the  button on the front panel to open the arbitrary waveform generator function and enter the waveform generator function menu.
2. Connect the device to a computer with WaveEditor software using a USB cable.
3. Use Keysight IO software to communicate with the WaveEditor. For specific operations, please refer to the description in the "[Remote Control](#)" section. You can also use LAN or COM connection.
4. Double-click the WaveEditor icon to open the software.
5. Select a waveform file or draw an arbitrary waveform, click the icon  on the toolbar, and then select a waveform data download location to download the waveform to the device.

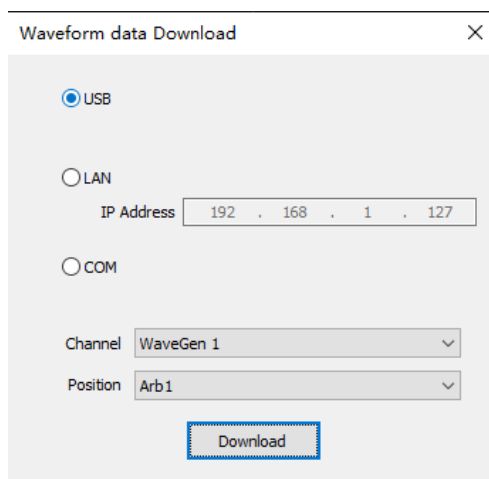

6. The GEN OUT BNC port will output a waveform.

The user can also call up the .arb file in the USB storage device to output the waveform: Press the [Wave Gen] button on the front panel to enter the waveform generator function menu.

Press the "Waveform" soft key, rotate V0 to select Arb1~Arb4, and then press V0 to confirm.

Press the "Recall" soft key and select the .arb file to be recalled from the USB storage device.

Modulation

The built-in signal source of DPO6000 / MPO6000 series oscilloscopes supports AM, FM, PM, and PWM modulation functions. The modulated waveform consists of a carrier wave and a modulated wave. The carrier signal is a waveform signal output by the signal source, and the modulation signal can be selected from the built-in sine wave, square wave, and triangle wave.

Amplitude modulation

Amplitude Modulation (AM), that is, the amplitude of the carrier wave changes with the modulation wave.

1. Turn on the modulation function

Press **WaveGen**-> Modulation-> Modulation on the front panel.

2. Set AM modulation

Press **WaveGen**-> Modulation-> Type on the front panel and select AM.

3. Set the modulation waveform

Press the front panel **WaveGen**-> Modulation-> Waveform Sine, Square, and Triangle.

4. Set the modulation frequency

Press **WaveGen**-> Modulation-> Frequency on the front panel.

5. Set the modulation depth

Press **WaveGen**-> Modulation-> Depth on the front panel.

Frequency modulation

Frequency modulation (FM), that is, the frequency of the carrier wave changes with the modulation wave.

1. Turn on the modulation function

Press **WaveGen**-> Modulation-> Modulation on the front panel.

2. Set FM modulation

Press **WaveGen**-> Modulation-> Type on the front panel and select FM.

3. Set the modulation waveform

Press the front panel **WaveGen**-> Modulation-> Waveform Sine, Square, and Triangle

4. Set the modulation frequency

Press **WaveGen**-> Modulation-> Frequency on the front panel.

5. Set the modulation frequency offset

Press **WaveGen**-> Modulation-> Deviation on the front panel.

Phase modulation

The modulated waveform of Phase Modulation (PM) usually consists of a carrier wave and a modulated waveform. The phase of the carrier wave changes with the instantaneous voltage of the modulated waveform.

1. Turn on the modulation function

Press **WaveGen**-> Modulation-> Modulation on the front panel.

2. Set PM modulation

Press **WaveGen**-> Modulation-> Type on the front panel and select PM.

3. Set the modulation waveform

Press the front panel **WaveGen**-> Modulation-> Waveform Sine, Square, and Triangle.

4. Set the modulation frequency

Press **WaveGen**-> Modulation-> Frequency on the front panel.

5. Set the modulation frequency offset

Press **WaveGen**-> Modulation-> Deviation on the front panel.

Pulse Width modulation

The modulated waveform of the Pulse Width Modulation (PWM) consists of a carrier wave and a modulation waveform, and the pulse width of the carrier wave changes with the instantaneous voltage of the modulation waveform.

1. Turn on the modulation function

Press **WaveGen**-> Modulation-> Modulation on the front panel.

2. Set PWM modulation

Press **WaveGen**-> Modulation-> Type on the front panel and select PWM.

3. Set the modulation waveform

Press the front panel **WaveGen**-> Modulation-> Waveform Sine, Square, and Triangle.

4. Set the modulation frequency

Press **WaveGen**-> Modulation-> Frequency on the front panel.

5. Set the modulation depth

Press **WaveGen**-> Modulation-> Depth on the front panel.

Burst

The DPO6000 / MPO6000 can output waveforms with a specified number of cycles.

1. Enable the burst function

Push the front panel **WaveGen**-> Burst.

2. Set the count value

Press **WaveGen**-> Burst-> Count on the front panel.

3. Set the data source

Press **WaveGen**-> Burst-> Data Source on the front panel to select Manual, Pass / Fail, DSO Trigger.

Manually:

The manual trigger source controls the burst output. At this time, the "Trigger" button is optional. Pressing "Trigger" once, the signal source outputs a waveform with a set number of cycles.

Pass failed:

Run the [Pass / Fail] test, turn on the "Output" and select "Output to DDS", the system will automatically turn on the "Burst" switch under the corresponding signal source, and the "Count" defaults to 1. According to the test results, the specified signal source outputs a waveform with a set number of cycles.

DSO Trigger:

Each time the waveform in the oscilloscope triggers, the current signal source outputs a waveform with a set number of cycles.

Pass / Fail test

The pass / fail test function is mainly used to evaluate the signal quality. By setting rules in the oscilloscope to test the waveforms in real time, counting the number of tests within the specified test conditions, the number of pass / fail data frames, and displaying the test results.

Enable pass / fail test

Press [Utility] -> "Pass / Fail"-> "Enable test"->"On" to enable the test function. The shaded area indicates the failure area. If the waveform measured at a time during the measurement passes through the failure area, it is determined as a failure frame.

Note: When the Time Mode is set to X-Y mode, ROLL mode or the horizontal time base is set to 200 ms / div or slower in YT mode, when the instrument enters the "slow scan" mode, this function cannot be enabled.

1. Data source

Before selecting the data source, you need to connect the signal under test to the analog channel input of the oscilloscope. Press the "Data Source" soft key to select the channel (CH1-CH4) to be tested. Note: Only channels that are already open can be selected.

2. Rule

Users can customize the rules for pass / fail tests. Press the "Horizontal" and "Vertical" soft keys respectively, rotate V0 to adjust the pass / fail rule. Press the "Create" soft key to apply the current rule. The oscilloscope prompts "Mask created!".

3. Test and output

The user can set the output format of the test results as follows.

Press the **Message** soft key to select whether to display the test results.

Press the **Stop On Output** soft key and select On or Off.

On: When the oscilloscope detects a waveform that matches the set "Mode", the test stops immediately and enters the STOP state. The information displayed on the screen at this time is the statistical result as of STOP. If "On" is selected for "Output", the pulse

displayed on the rear panel [Aux Port] will disappear immediately.

Off: When the oscilloscope detects a waveform that matches the set "Mode", the test continues. The information displayed on the screen continues to update in real time. If "On" is selected for "Output", the [Aux Port] on the rear panel will output a pulse.

Press the **Output** soft key to select whether to output the test results. When the oscilloscope detects a waveform that matches the set "mode", the Aux port on the rear panel outputs a waveform; when it does not detect a waveform that matches the set "mode", there is no output.

Press the **Mode** soft key:

Pass: When a pass is detected, the statistical results and output pulses are displayed, and the buzzer does not alarm.

Failure: When a failure is detected, the statistical results and output pulses are displayed, and the buzzer does not alarm.

Pass ring: When one pass is detected, the statistical result and output pulse are displayed, and the buzzer alarms (not related to the sound switch state).

Failure ring: When a failure is detected, the statistical result and output pulse are displayed, and the buzzer alarms (not related to the sound switch state).

Press the **Output to DDS** soft key to select the test result output path.

Select the output to the signal source (GEN1 / GEN2 / GEN3, the oscilloscope automatically turns on the burst enable of the corresponding signal source, and set the "Source" to "Pass / Fail", the user only needs to manually enable the corresponding signal source to enable) or directly Output from the AUX port on the rear panel (off, the user need to manually set "Utility"-> "AUX" to select Pass / Fail).

For the setting of the signal source, please refer to section [Burst](#).

Segmented acquisition

Segmented storage when multiple triggers are made in the acquisition process, the data obtained for each trigger sampling is stored in the storage space of each segment.

Segment storage principle

As shown in the figure below, the data collected when the first trigger occurs is stored in the first segment of storage space, the data collected when the second trigger occurs is stored in the second segment of storage space, and so on, until When the number of segments set by the user is acquired, the oscilloscope enters the pause state to end the acquisition process. Read the first segment of the acquisition for display.

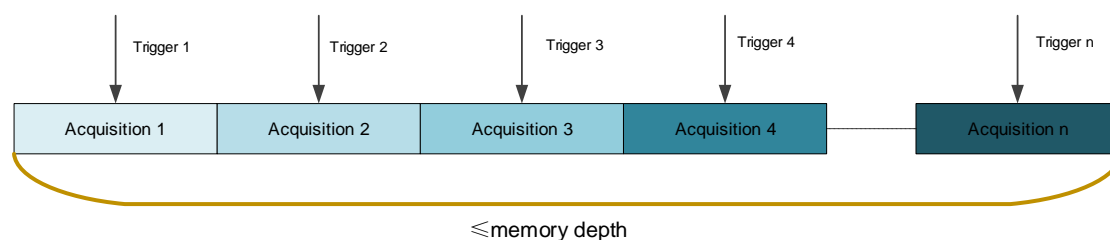

The MPO6000EDU oscilloscope is taken as an example. The total storage depth is 128Mpts. The formula for calculating the number of segments is as follows:

$$N = 128 \times 1024 \times 1024 / [\text{round the current storage capacity to } 2^n] - 1.$$

Segment settings

The maximum storage of MPO6000EDU oscilloscope is 128Mpts. With the 1GSa / s sampling rate, the segment storage range is supported: 1~80,000 segments, and the maximum length of a single segment is 32K.

1. Enable segmented acquisition

Utility-> Acquisition-> Segmented Acquisition-> Segmented Acquisition

2. Set the number of segmented acquisition segments

Utility-> Acquisition-> Segmented Acquisition-> Segmentation Setting: Set the number of segments for segmented acquisition

3. Set the segmented collection to view the segment value

Utility-> History Waveform-> Frames: Set the waveform display screen to display the corresponding frame number after the segment acquisition is finished.

4. Open and close the list





Utility-> History Waveform-> List: Turn on / off the segmented acquisition list function. Please turn on the segmented storage function before opening the list.

History waveform

When the user starts to use the oscilloscope, the oscilloscope will automatically acquire and store data, which can collect up to 80,000 frames. Open history waveforms to observe previously stored waveforms and perform measurement analysis on them. Users can also capture individual details or waveforms that change over time by setting time intervals and waveform navigation at different speeds. Each record is indexed by a time stamp, and the history waveform function can record the input waveform for a period of time before STOP.

The waveform playback function can play the currently recorded waveform. During playback, the information shown in the figure below will be displayed in the upper right

corner of the screen. The data on the left of the figure is the specific frame displayed on the current screen. During playback, this value is constantly changing. The data on the right indicates the maximum number of frames that have been recorded.

After enabling the segment acquisition function, press  to manually play the next frame; press  the automatic sequence to play the segment acquisition waveform. The playback interval can be set by the interval. The minimum value of the automatic playback interval is 10ms; press  to pause the automatic playback; Press  to play the previous frame manually.

Display control

Users can set the waveform display type, persist time, waveform brightness, grid type and grid brightness displayed on the screen, and the color display type of the waveform.

Display type

Press -> Display Type to set the waveform display mode to "Vector" or "Dot".

Vector display: The sampling points are displayed by connecting lines. This mode provides the most realistic waveform in most cases. Easily view the steep edges of a waveform, such as a square wave.

Point display: directly display the sampling point. The user can see each sampling point intuitively and can use the cursor to measure the X and Y values of that point.

Grid

Press -> Screen Grid to set the screen grid type.

1. Show only vertical and horizontal center grid
2. Show only vertical and horizontal center grids, and use dot display to draw other horizontal and vertical grids
3. Show only vertical and horizontal center grids, and use line display to draw other horizontal and vertical grids

Waveform brightness

Press -> Waveform Brightness, or in the case of non-menu operation, turn V0 to adjust the waveform brightness value of the channel. The default is 50% and the adjustable range is from 0% to 100%.

Grid Brightness

Press -> Grid Brightness to set the screen grid brightness. Turn V0 to adjust the

grid brightness. The default is 50% and the adjustable range is from 1% to 100%.

Screen brightness

Press **Display**-> Screen Brightness to set the screen brightness. Turn V0 to adjust the grid brightness. The default is 80% and the adjustable range is from 1% to 100%.

Color grade

The color grade function uses the color change to reflect the frequency of waveform appearance. The more frequently the waveform appears, the warmer the color. The less frequent it appears, the cooler the color. The picture below is a gradient picture of cool and warm colors.

Press **Display**-> Color grade on the front panel and select "On" to enable the color grade function. You can compare the color of the currently displayed waveform with the figure below to determine the probability of the waveform appearing.

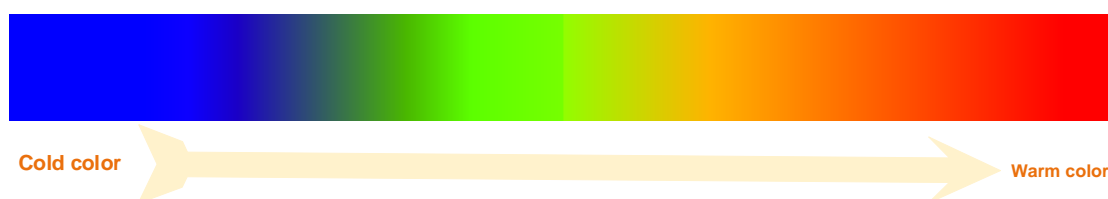

Persist time

Press **Display**-> Persist Time to set the oscilloscope's persist time to the minimum value, specific value (minimum value, 1 s, 5 s, 10s, and 30 s) or infinite. The following uses sine wave sweep signals to demonstrate the waveform effect under different persist times.

1. Minimum value

Observe waveforms that change at high refresh rates.

2. Specific value

Observe glitches that change more slowly or appear less prone. The afterglow time can be set to: 1s, 5s, 10s, and 30s.

3. Infinite

When the oscilloscope displays a newly acquired waveform, it will not clear the previously acquired waveform. The acquired waveform is displayed in a lower brightness color, and the newly acquired waveform is displayed in normal brightness and color. Use infinite persistence to measure noise and jitter and capture infrequent events.

Store and recall

Users can save the current oscilloscope settings, waveforms, reference waveforms, CSV files, and screen images in various formats in the internal flash memory or USB storage device. The reference waveform can be compared with other waveforms to determine the cause of the failure.

Save

Save type

1. Set

Save the oscilloscope settings to internal memory or external memory, the format is .set.

2. Waveform (binary)

Save the oscilloscope waveform to internal memory or external memory, the format is .lwf.

3. Reference waveform

Save the oscilloscope reference waveform to internal memory or external memory, the format is .ref.

4. CSV

Save the waveform data to the external memory, you can specify the file name and save path, the format is .csv. The storage file contains the waveform data of the display channel and the main setup information of the oscilloscope.

Save directory

The storage path includes internal flash memory and external storage. The internal flash memory can store up to 9 files (No. 1 to No. 9). The external storage can specify the file name and the storage path. In addition to CSV files, saved files can be recalled.

Recall

Recall type

1. Set

Recall the .set setting file from the internal or external memory of the oscilloscope.

2. Waveform (binary)

Recall the .lwf waveform file from the internal or external memory of the oscilloscope.

3. Reference waveform

Recall the .ref reference waveform file from the internal or external memory of the oscilloscope.

Recall directory

The recall path includes internal flash memory and external memory. The internal flash memory can recall up to 9 files (No. 1 to No. 9), and the external memory can specify the file name and path to recall.

Utility function

Language

This oscilloscope provides Chinese and English help information, prompt information, and interface display. Press **Utility** -> Language, turn the multi-function knob to select the desired language, and press the multi-function knob to select the language.

Touch screen

This oscilloscope supports manually switching the touch screen. Press **Utility** -> touch screen to switch the touch screen.

System information

Press **Utility** -> System Information to view the user's oscilloscope system information. System information includes manufacturer, model, serial number, and software and hardware version numbers.

Pass failed

In the pass / fail test, when the oscilloscope detects a waveform that meets the pass / fail rule and output mode, it will output a pulse through the Aux port on the rear panel ([Function Reuse] select "Pass / Fail"); When the waveform of the above conditions fails, there is no output from this port. For a detailed introduction of the pass / fail test function, please refer to the description in "[Pass / Fail Test](#)".

Upgrade firmware

DPO6000 / MPO6000 can upgrade firmware through USB storage device. The whole process takes about 3 minutes.

Please upgrade the oscilloscope as follows:

1. Insert the storage device into the USB Host interface on the front panel.
2. Press **Utility** -> Upgrade -> Upgrade Firmware -> Manually select the firmware file ->

Start the upgrade process.

3. Use multi-function knob V0 to select the .upk file to be upgraded, and press multi-function knob V0 to select the upgrade file.
4. After the upgrade is completed, a prompt message will pop up on the screen to remind the user that the upgrade has been successful and the oscilloscope will restart automatically.
5. Press the **F5** back key to cancel the upgrade.

Calibration

Performing the calibration procedure can quickly make the oscilloscope reach the best working condition to obtain the most accurate measurement value. The user can execute the program at any time, especially when the ambient temperature variation range reaches or exceeds 5 ° C. Before performing the self-calibration operation, make sure that the oscilloscope has been warmed up or run for more than 30 minutes. Disconnect all input channels and press **Utility**-> Calibration.

AUX

Press **Utility** -> AUX to set the type of signal output from the Aux port on the rear panel.

Trigger output

The oscilloscope generates a trigger, and the interface will output a signal reflecting the current capture rate of the oscilloscope. Connect this port to the waveform display device to measure the frequency of the output signal. The measurement result is the same as the current capture rate.

Pass / fail

When the oscilloscope tests a waveform that meets the pass / fail rule and output mode, it will output a pulse signal. For details, please refer to the introduction in "[Pass / Fail Test](#)".

System settings

Sound

Press **Utility**-> System Settings-> Sound. After turning on the sound, you can hear the buzzer sound when operating the menu or popping up a prompt message. Sound is turned on by default.

Network

Wlan0

"Status", "DHCP", "Auto IP" select "On" to search for nearby wireless networks and display them in the "Scan Results" list on page 3. Use the V0 knob to select the wireless network to be connected, press the button to confirm, or manually enter the wireless network name, enter the password in "PSK", and press "OK". At this time, the screen displays "WIFI is connected", and the lower right corner of the screen a blue WIFI icon is displayed.



You can control the oscilloscope on the PC by searching for the IP address of the oscilloscope on the wireless network PC browser.

The PC browser display interface is as follows:

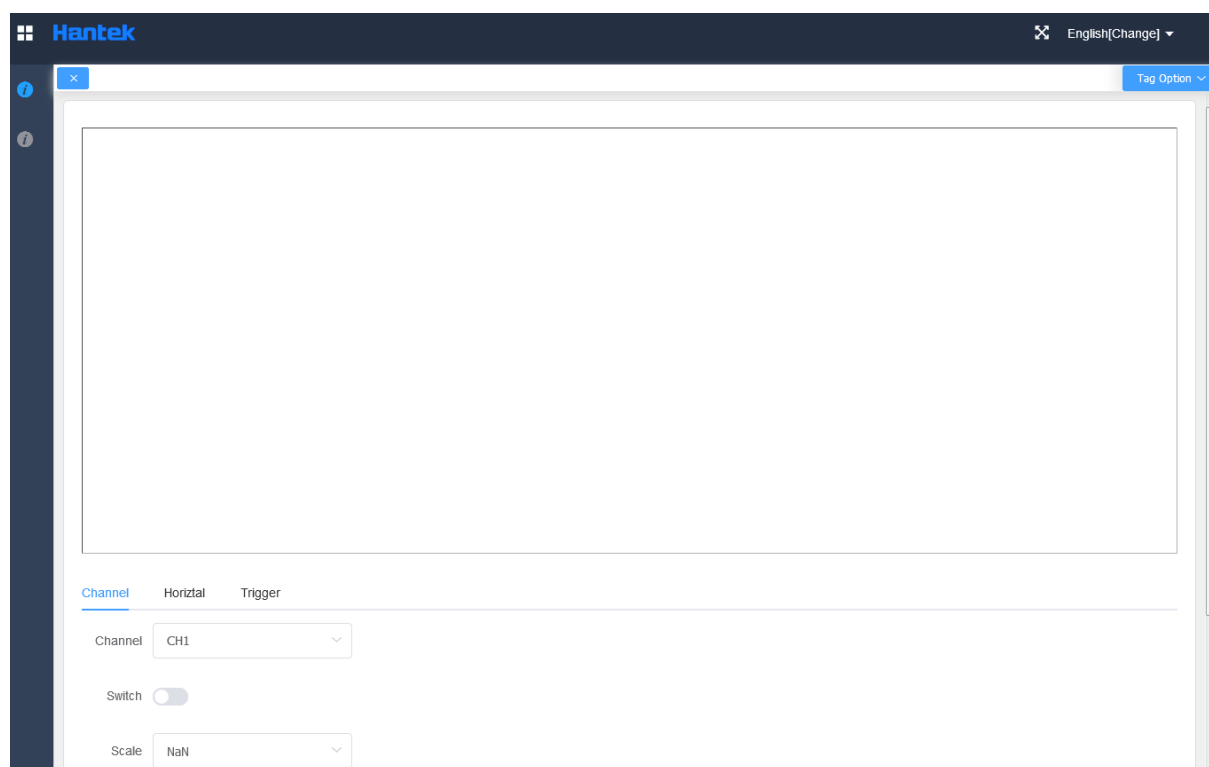

Hot spot

Select "wlan0" for the network, "On" for "Status" and "DHCP", and "On" for the "Hot" status. The gray WIFI icon is displayed in the lower right corner of the screen. When a user successfully connects to the hotspot, the number of current users is displayed in the WIFI icon.

The client can set the IPv4 address manually or automatically. The client's IP address

should be set in the starting IP and ending IP segments. The subnet mask and router settings are the same as the oscilloscope.

Network	← Back DPO6204B_undefined	
Users	Forget This Network	
8		
IP Start	Auto-Join <input checked="" type="checkbox"/>	
10.0.0.223		
IP end	IPV4 ADDRESS	
10.0.0.240	Configure IP Automatic >	
Subnet Mask	IP Address 10.0.0.238	
255.255.255.0	Subnet Mask 255.255.255.0	
Confirm	Router 10.0.0.1	
2/3		

Eth0

"Network" select "eth0" to set the network port communication to remotely control the oscilloscope. For the setting procedure, please refer to "Control via LAN" under "[Remote Control](#)".

Time

Set the year, month, day, hour, minute, and second.

Touch calibration

Follow the prompts to calibrate the touch screen.

Self-test and front-panel self-test

Self-test and front-panel self-test include screen test, keyboard test, and lighting test. It is mainly used to check whether there are mechanical problems with the oscilloscope, such as the display color deviation, the response sensitivity of the buttons and knobs, and whether the button lights are on.

Conditional Search

The condition search function is used to search for the position that meets the trigger condition after the trigger point after the waveform trigger, and is identified by the lower triangle symbol.

Remote control

There are three main ways to remotely control the oscilloscope:

1. Control via USB
2. Control via LAN
3. Control via serial port

Control via USB

Use a USB data cable to connect the USB Device interface on the rear panel of the oscilloscope with the USB interface of the computer. A new device will display in device manager.

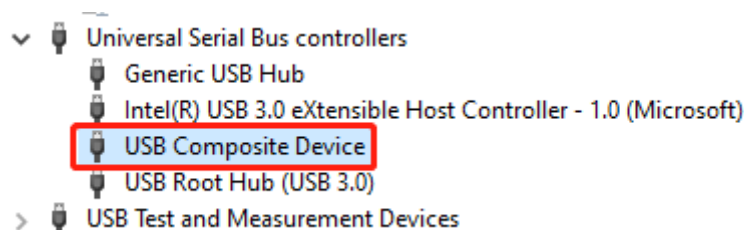

Install the IO software (Keysight IO libraries suite):

Click the following URL to download the latest software:

<https://www.keysight.com/main/software.jsp?ckey=2175637&lc=chi&cc=CN&nid=-11143.0.00&id=2175637>

Double-click the application to begin installation. Follow the installation prompts to install step by step. The installation process may take several minutes.

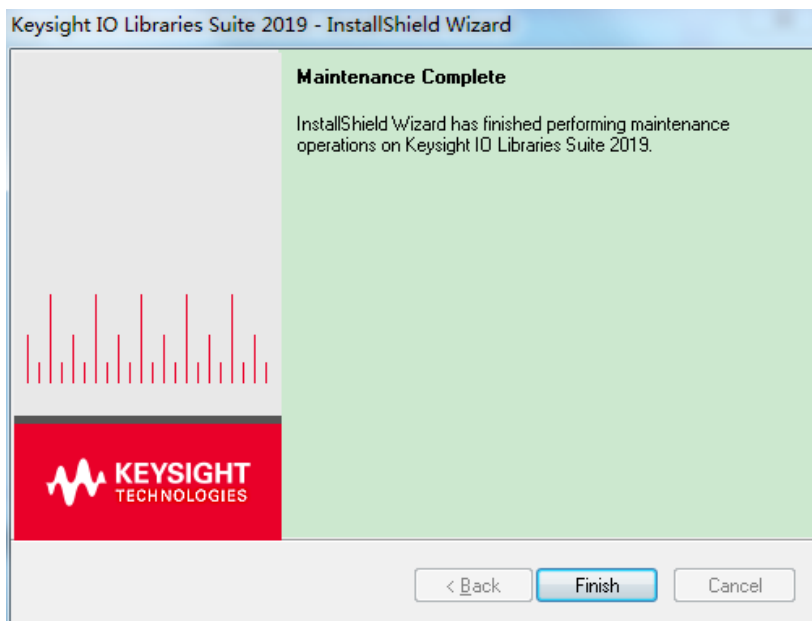
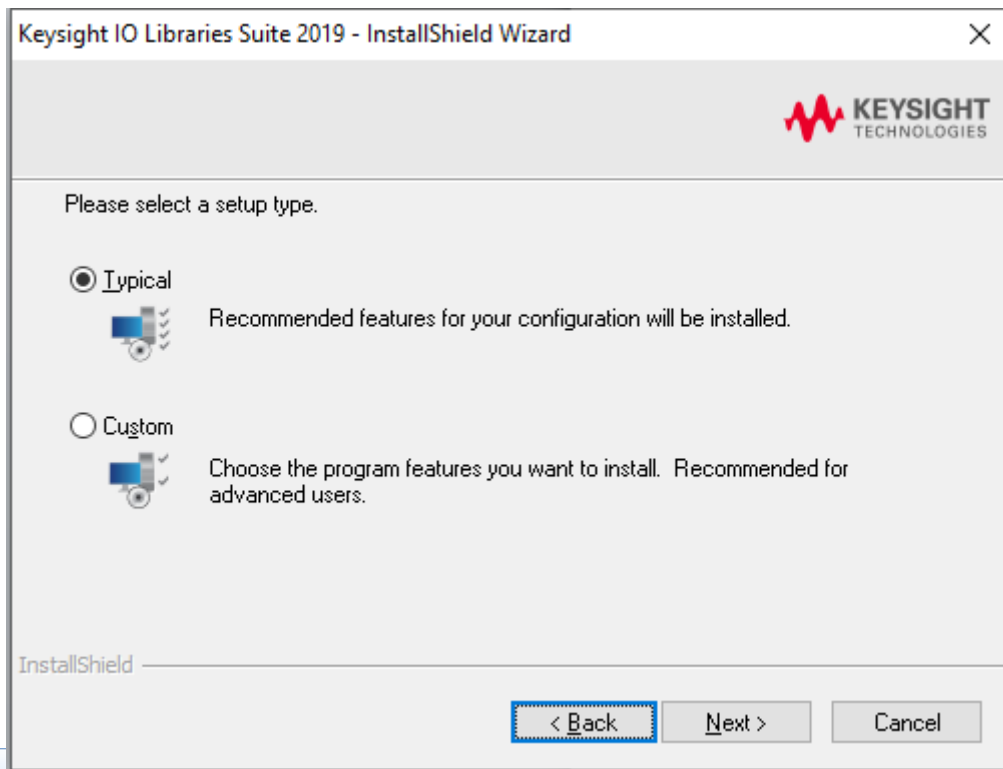

You can see the running IO software in the lower right corner of the screen after the installation is complete.

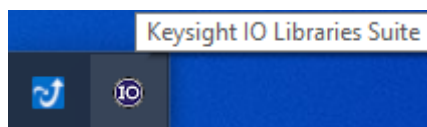

Double-click to open the IO software; you can see the connected device information displayed under My Instrument-USB.

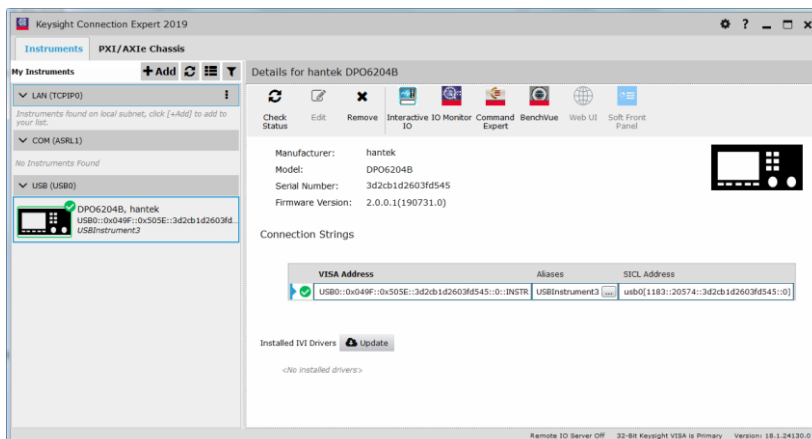

Click "Interactive IO"; send any command, the computer and the oscilloscope get communication.

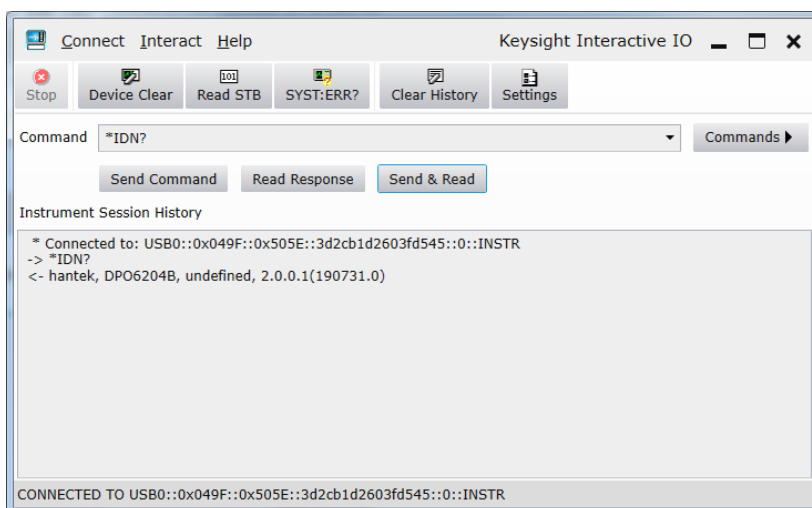

Double-click to open the host computer software, click File-> Connection-> Connection Method, and select USB connection. At this time, the lower left corner of the host computer software is displayed as connected.

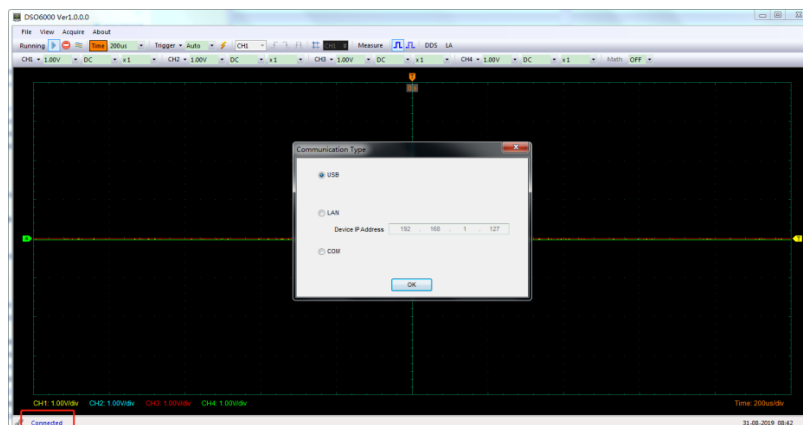
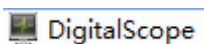

At this point, the oscilloscope screen displays "Keyboard lock. Press the help key three times to unlock the keyboard." If you want to control the oscilloscope by pressing keys, you need to close the host computer software first and press Help three times to unlock the keyboard.

Control via LAN

Use a network cable to connect the network port on the back panel of the oscilloscope to the network port on the computer. The network cable connected icon is displayed in the lower right corner of the oscilloscope screen.

Set the oscilloscope network parameters: **Utility**-> System Settings-> Network set the corresponding IP address, subnet mask, gateway, DNS and confirm.

Network	Network
Network	Ip
eth0	192.168.1.127
Status	Subnet Mask
ON	255.255.255.0
DHCP	Gateway
OFF	192.168.1.1
AutoIP	DNS
OFF	192.168.1.1
Confirm	Confirm
1/4	2/4

Set the computer network parameters: Open Network Connections-> Status-> Change your network settings-> Change adapter options->Ethernet-> Properties-> Internet Protocol Version 4 (TCP / IPv4), set the computer's IP address to 192.168.1.2 or other (192.168.1.2~192.168.1.255) except Any IP other than the oscilloscope IP (default IP is 192.168.1.127), the subnet mask is set to the default value.

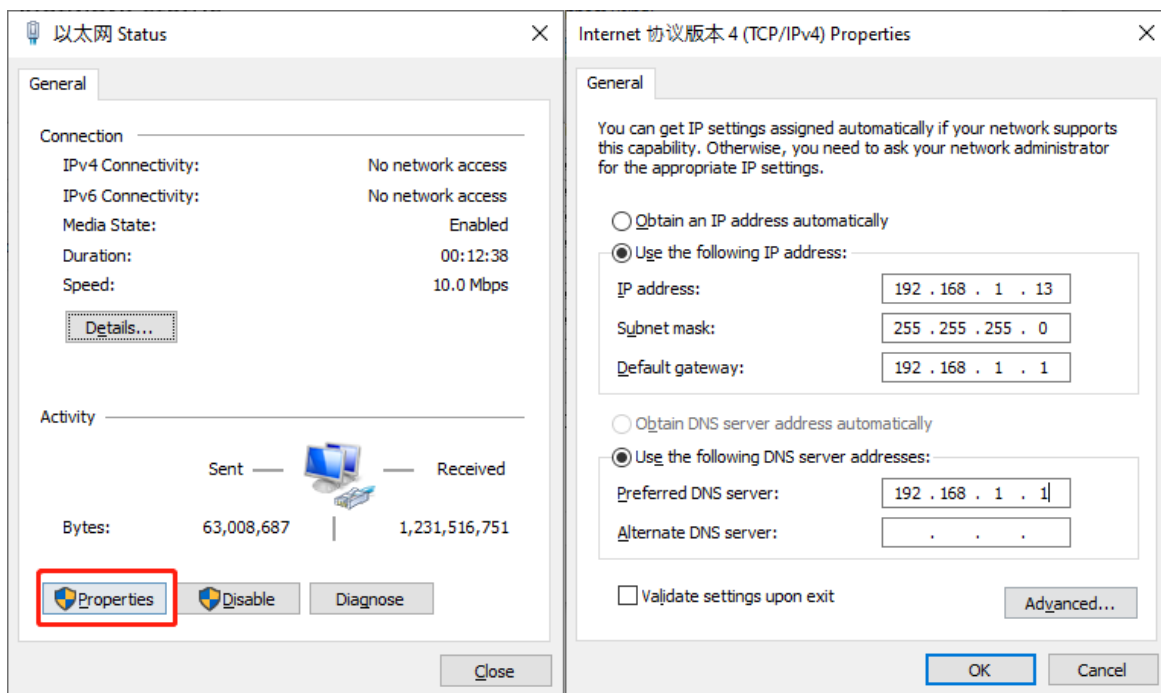
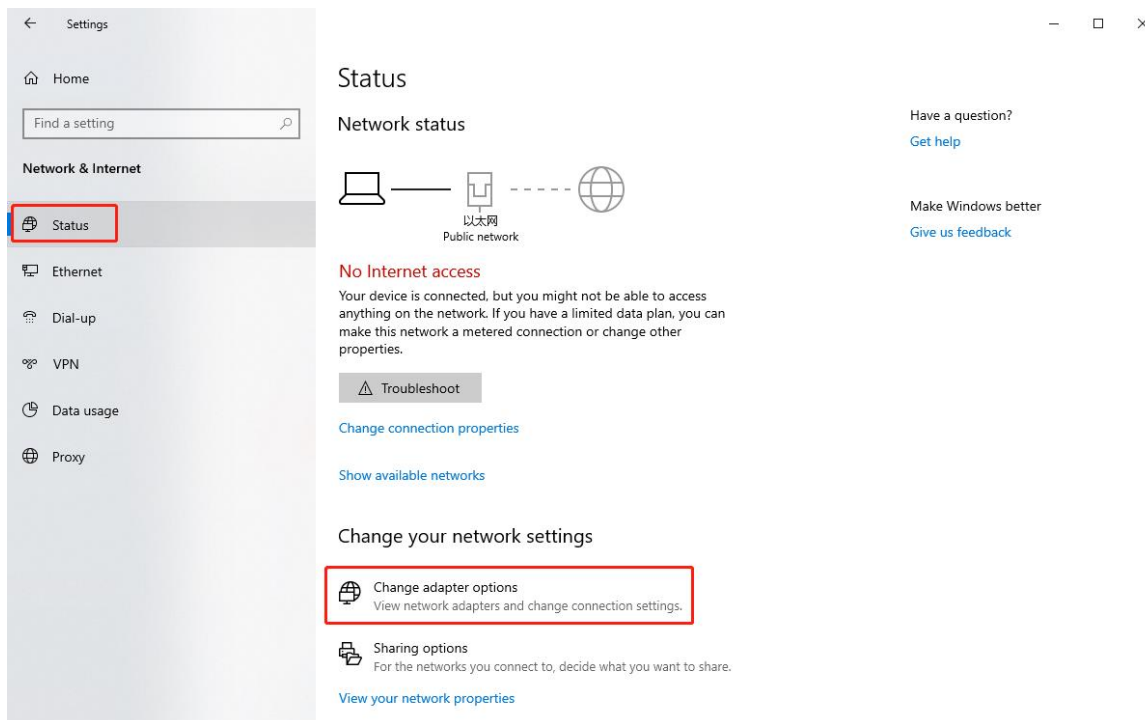

Double-click to open the IO software and select the recognized device.

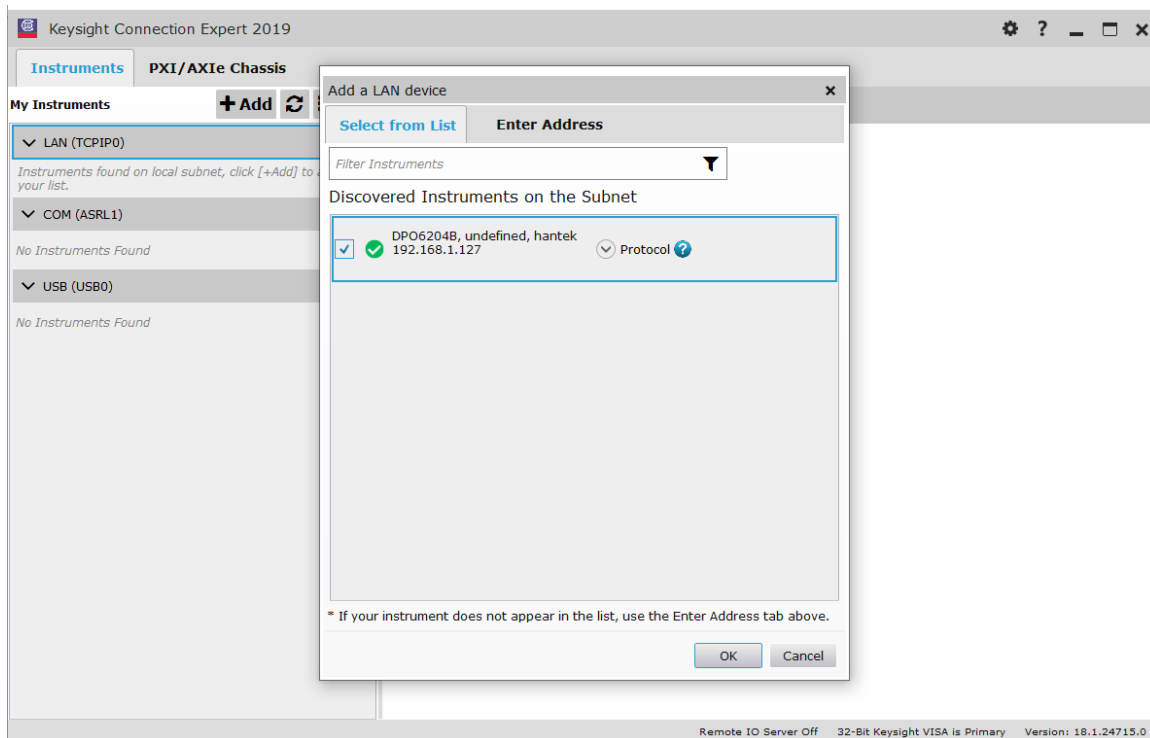

Click "Interactive IO", send any command, the computer and the oscilloscope get communication.

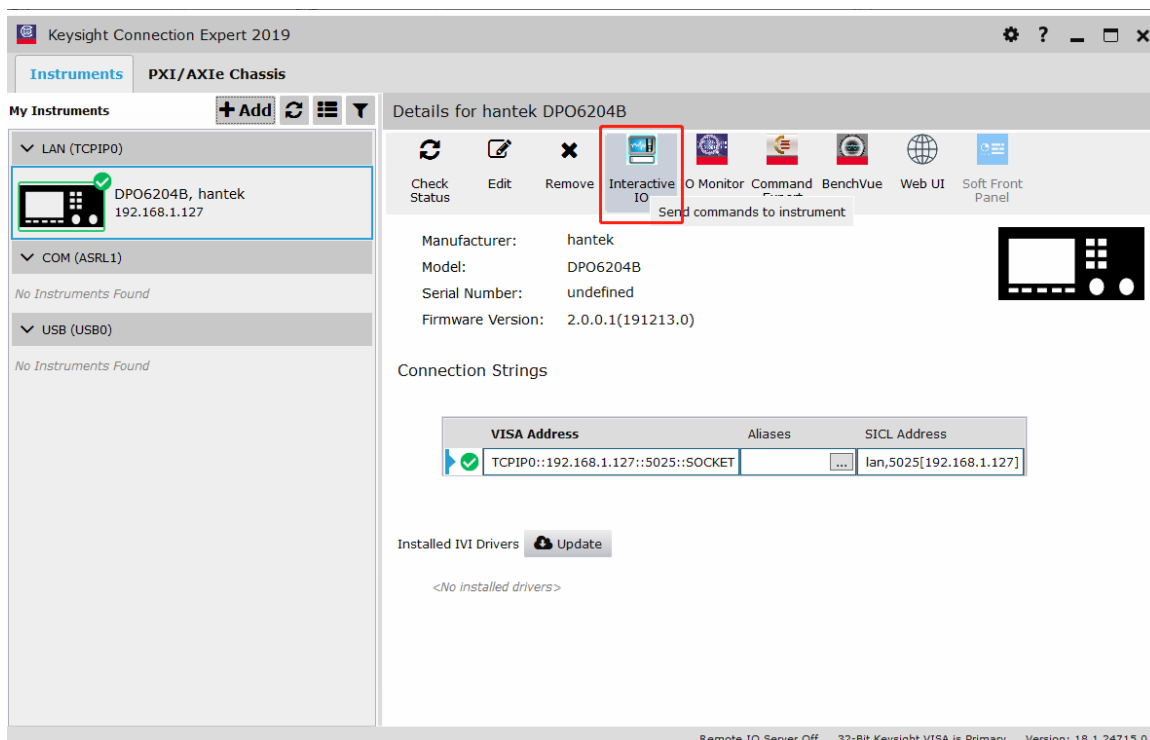

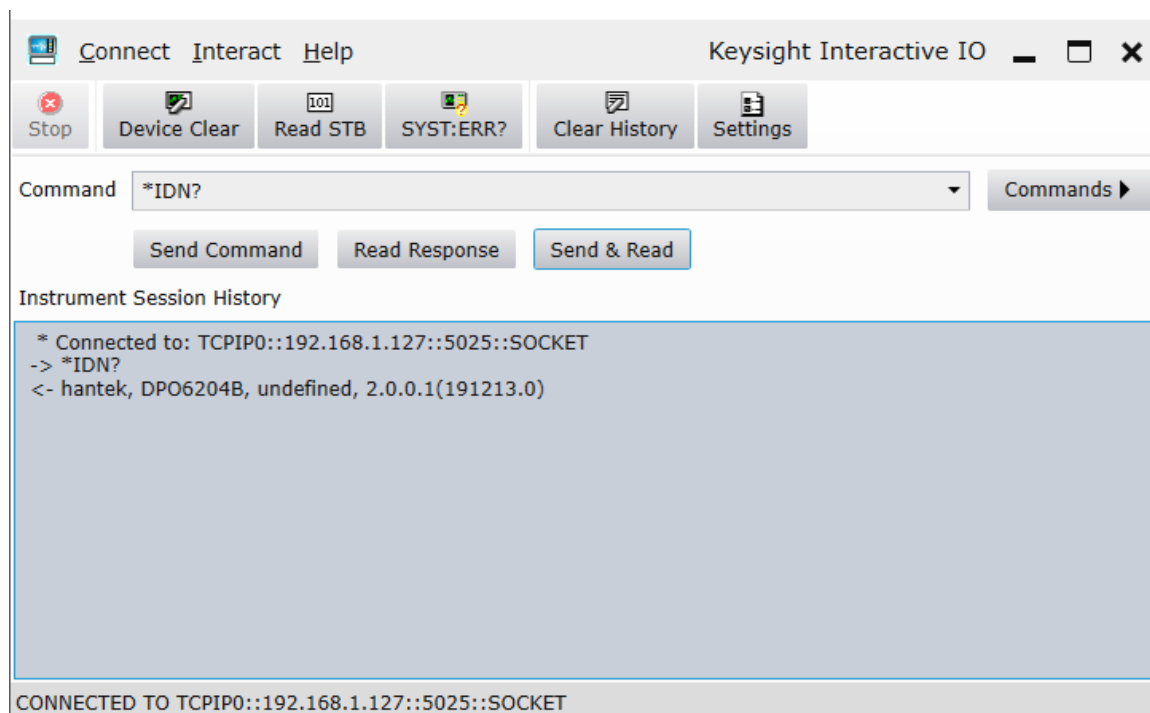

Double-click to open the PC software, click File-> Connection-> Connection Method, and select LAN connection. At this time, the lower left corner of the host computer software is displayed as connected.

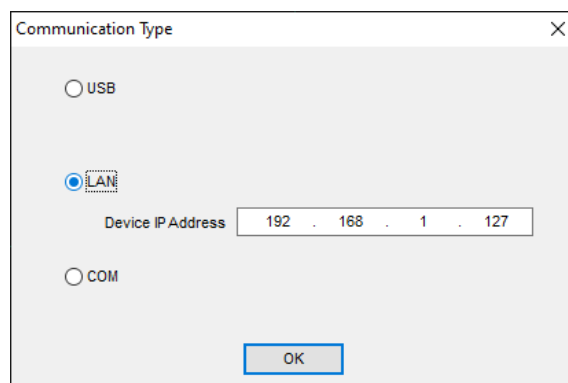
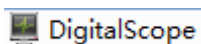

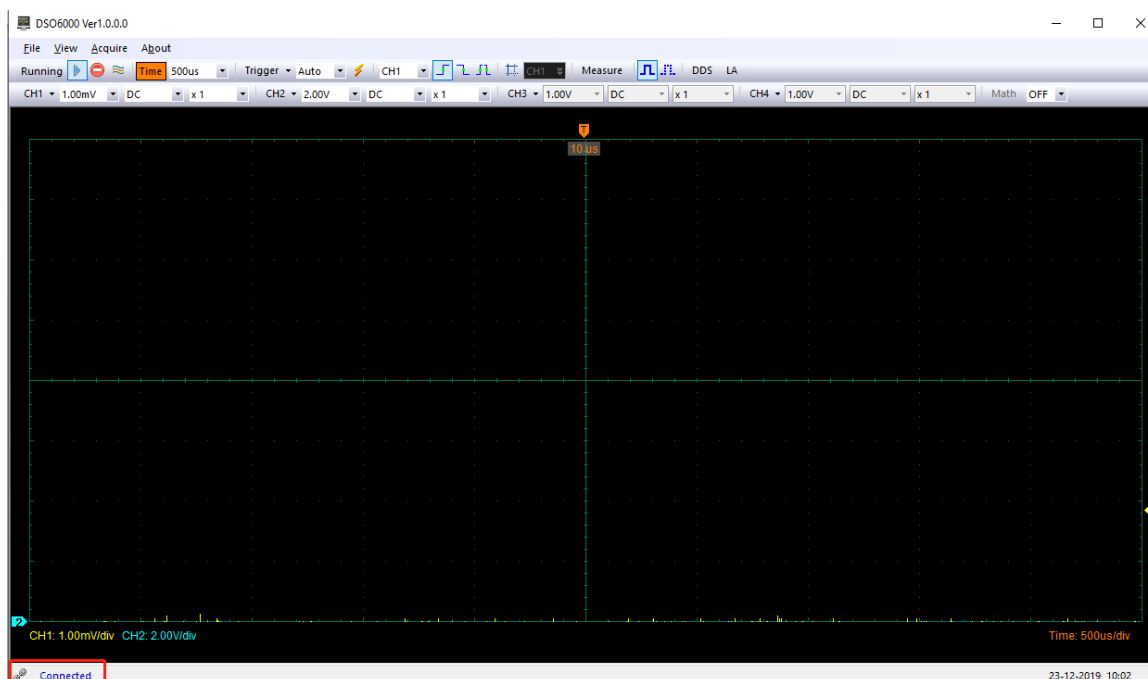

At this point, the oscilloscope screen displays "Keyboard lock. Press the help key three times to unlock the keyboard." If you want to control the oscilloscope by pressing keys, you need to close the host computer software first and press Help three times to unlock the keyboard.

Control via serial port

Connect the network port of the network port to serial cable to the network port on the rear panel of the oscilloscope, and connect the serial port to the computer.

Open the IO program, select "Add Device" and set the serial port properties. The baud rate is 115200.

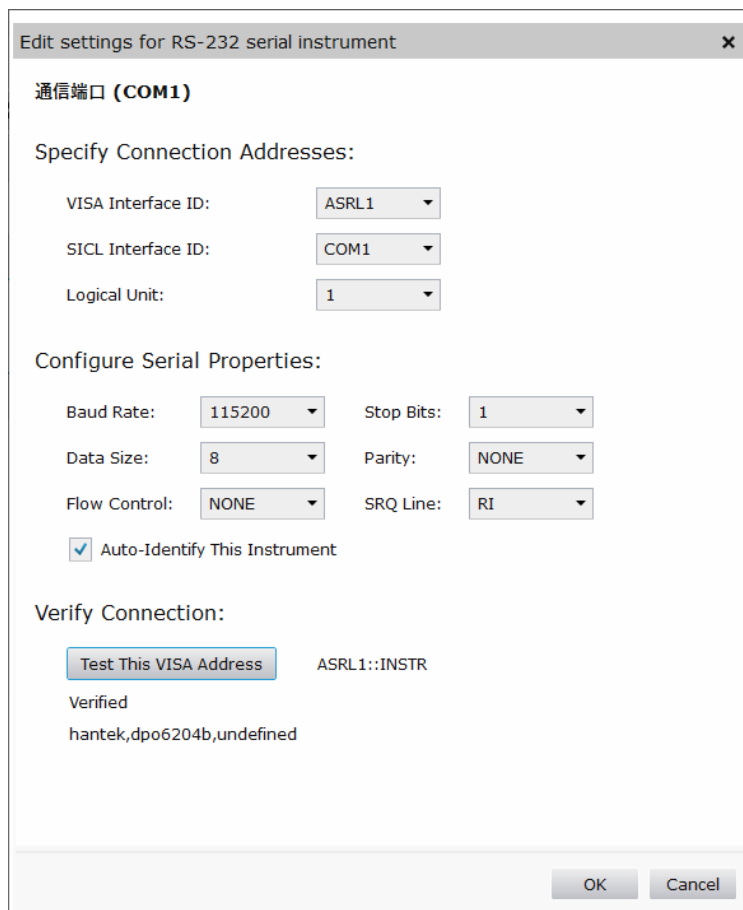

The IO software "My instrument" COM list shows the connected devices, click "interactive IO", and send any command, the computer and the device get communication.

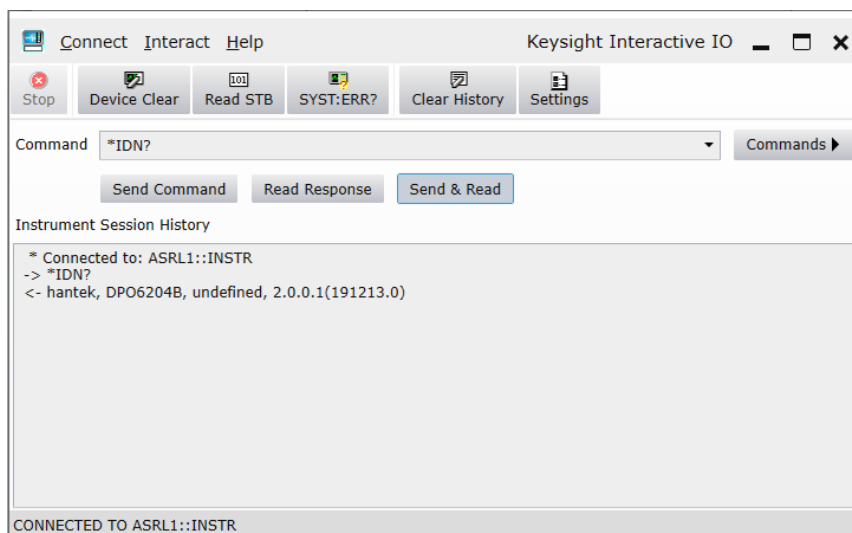

Double-click to open the host computer software, click File-> Connection-> Communication type, and select COM connection. At this time, the lower left corner of the host computer software is displayed as connected.

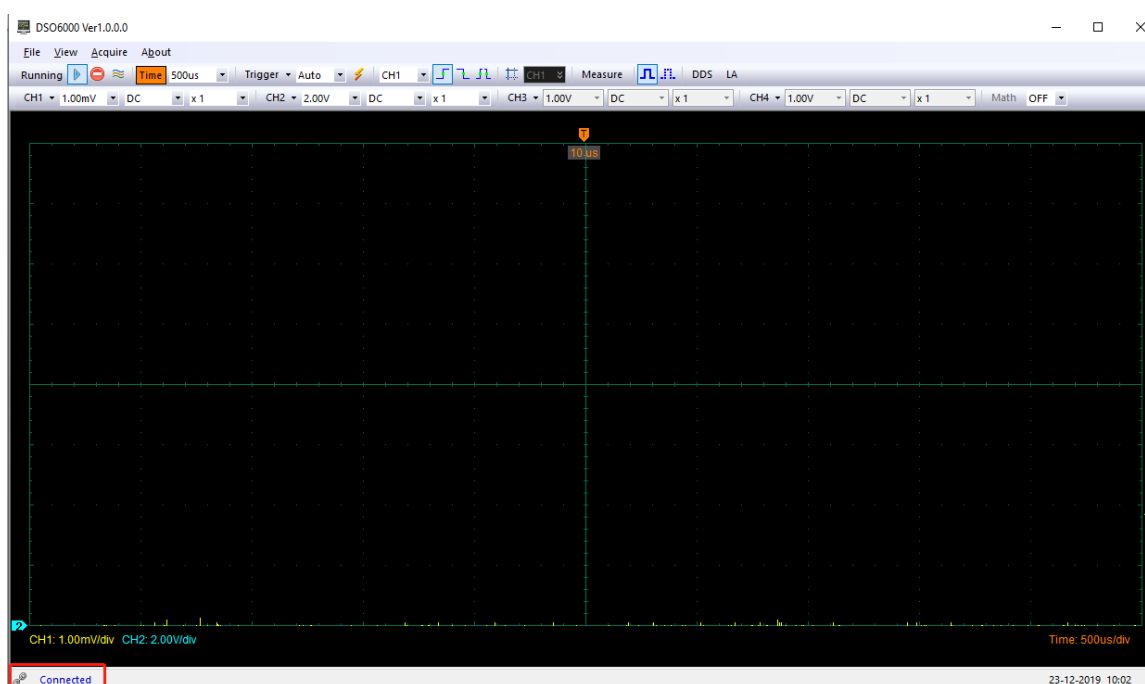
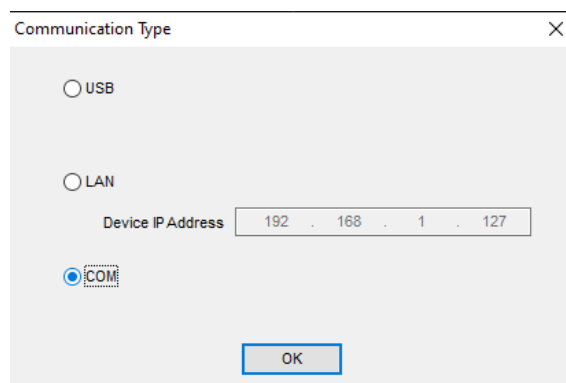

At this point, the oscilloscope screen displays "Keyboard lock. Press the help key three times to unlock the keyboard." If you want to control the oscilloscope by pressing keys, you need to close the host computer software first and press Help three times to unlock the keyboard.

Common faults and solutions

1. The oscilloscope does not turn on after pressing the power switch

- (1) Check whether the power cord on the side of the oscilloscope is connected normally.
- (2) Check if the power switch is pressed.
- (3) After completing the above inspections, turn on the instrument again.

If the oscilloscope still does not turn on normally, please contact your local dealer or directly contact Hantek Technical Support.

2. No waveform is displayed on the input signal screen after the oscilloscope is turned on.

- (1) Check whether the oscilloscope probe is correctly connected to the BNC connector of the signal input channel.
- (2) Check whether the channel switch is on (CH1~CH4 menu button).
- (3) Check whether the input signal is correctly connected to the probe.
- (4) Check if there is signal output from the measured circuit.
- (5) If it is a DC signal and the amplitude is relatively large, please increase the amplitude.
- (6) You can press the automatic measurement button to automatically detect the signal first.

If there is still no waveform display, please contact Hantek Technical Support in time.

3. The input signal waveform distortion is serious

- (1) Check if the oscilloscope probe is connected to the channel BNC connector.
- (2) Check whether the probe is well connected with the measured object.
- (3) Check whether the oscilloscope probe is calibrated properly. If there is no calibration, please calibrate according to the relevant content in the manual.

4. The waveform continuously scrolls on the screen and cannot be triggered.

- (1) Check whether the trigger data source is consistent with the signal input channel.
- (2) Check whether the trigger level is adjusted correctly. You can press the trigger level knob to return the trigger level to the signal center point.
- (3) Check whether the trigger mode is correct, because the default trigger is edge trigger. For different input signals, the trigger mode should be selected correctly.

Technical specifications

All technical specifications are applicable to the DPO600 / MPO6000 series digital storage oscilloscopes. For details, see the last part of this chapter. To verify that the oscilloscope meets the technical specifications, the oscilloscope must first meet the following conditions:

- The oscilloscope must have been working continuously for more than 20 minutes within the specified operating temperature.
- If the operating temperature changes by more than 5 degrees Celsius, you must perform the “self-calibration” operation. This operation can be performed through the [Utility] menu.

- The oscilloscope must fall within the factory calibration period.

All specifications are guaranteed to meet the requirements except those marked as "Typical."

Oscilloscope technical specifications

Acquire

Acquisition method	Normal, average, peak, high resolution
Real-time sampling rate	1 G Sa/s (single channel) 500 M Sa/s (dual channel) 250 M Sa/s (three / four channels);
Peak Detect	Analog Channel 4ns
Averaging mode	N samples for analog channels (N values: 2, 4, 8, 16, 32, 64, 128, 256, 512, and 1024)
High resolution	12bit
Minimum detection pulse width	8ns
Memory Depth	Single Channel 64M / 128M [EDU] Dual channel 32M / 64M [EDU] Three or four channels 16M / 32M [EDU]

Input

Number of channels	4 analog channels, 16 (4 * 4) digital channels The number of analog and digital channels opened at the same time should be less than 4.
Input coupling	DC, AC or GND Digital channels are not supported
input resistance DC coupling	Analog channel: 25pF ± 3pF, 1MΩ ± 2% Digital channels: (300KΩ ± 2%), (8 pF ± 3 pF)
Support probe attenuation coefficient	Analog channels 0.01X, 0.02X, 0.05X, 0.1X, 0.2X, 0.5X, 1X, 2X, 5X, 10X, 20X, 50X, 100X, 200X, 500X, 1000X, 2000X, 5000X, 10000X
Voltage rating 300V CAT II	300V CAT II
Input voltage	Analog channels 300VRMS (10X) Digital channel-25V~25V

Horizontal

Waveform Interpolation	Sine, Linear, Step
Horizontal scale	2ns/div~100s/div 1,2,5 steps
Time base mode	Y-T, X-Y, Roll
X-Y number	1, 2 channel combination 1 XY 3, 4 channels combined 1 XY
Zero offset	± 0.5 div × minimum time base scale

Sampling rate and delay time accuracy	$\pm 25\text{ppm}$
Clock drift	$\leq \pm 5\text{ ppm/year}$
Incremental time measurement accuracy (Full bandwidth)	single shot, "sampling" mode $\pm (1\text{ sampling interval} + 100\text{ppm} \times \text{reading} + 0.6\text{ns})$
	$> 16\text{ times average}$ $\pm (1\text{ sampling interval} + 100\text{ppm} \times \text{reading} + 0.4\text{ns})$
	Sampling interval = seconds / div $\div 200$

Vertical

Bandwidth (-3db)	DPO6084	DPO6104	DPO6204
	80MHz	100MHz	200MHz
Vertical resolution	Analog channel 8bit Digital channel 1bit		
Vertical scale	500 $\mu\text{V/div}$ ~10V/div at input BNC		
Position range	500 $\mu\text{V/div}$ to 128mV/div, $\pm 1\text{V}$ 129mV/div to 1.28V/div, $\pm 10\text{V}$ 1.29V/div to 10V/div, $\pm 50\text{V}$		
Selectable analog bandwidth limit, typically	20MHz		
Low frequency response (-3db)	$\leq 10\text{Hz}$ at BNC		
Rise time at BNC, typical	DSO6084	DSO6104	DSO6204
	$\leq 4.4\text{ns}$	$< 3.5\text{ns}$	$\leq 1.8\text{ns}$
Vertical gain accuracy	In the "normal" or "average" acquisition mode, the accuracy from 10V/div to 10mV/div is $\pm 3\%$. In "normal" or "average" acquisition mode, the accuracy from 5mV/div to 500uV/div is $\pm 4\%$.		
DC offset accuracy	$\pm 0.1\text{div} \pm 2\text{ mV} \pm 1\%$ offset value		
Channel Isolation	DC to Maximum Bandwidth: $> 40\text{ dB}$		

Note: The bandwidth is reduced to 6MHz when using the X1 probe

Vertical (digital channel: for MPO6000D / MPO600EDU or DPO6000B / DPO6000C purchase digital probe LP104)

Threshold	Adjustable threshold for 4 channels as a group
Threshold selection	TTL (1.4 V)
	5.0 V CMOS (+2.5 V)
	3.3 V CMOS (+1.65 V)
	2.5 V CMOS (+1.25 V)
	1.8 V CMOS (+0.9 V)
	ECL (-1.3 V)
	PECL (+3.7 V)

	LVDS (+1.2 V) 0V Custom
Threshold range	$\pm 7.0V$, 10Mv steps
Threshold accuracy	\pm (Threshold setting of 100mV + 3%)
Dynamic range	$\pm 5.0V$ + threshold
Minimum voltage swing	500 mVpp
Vertical resolution	1 bit

Trigger

Trigger level range	± 4 divisions from the center of the screen
Trigger mode	Auto, Normal, Single
Holdoff range	8ns ~ 10s
Trigger level accuracy	CH1~CH4 0.2 divisions \times volts / division within ± 4 divisions from the center display

Edge trigger

Slope	Rising, Falling, Rising or Falling
Data source	CH1~CH4, D1.0~D1.3, D2.0~D2.3, D3.0~D3.3, D4.0~D4.3
Pulse width trigger	
Polarity	Positive, Negative
Conditions	<, >, !=, =
Data source	CH1~CH4, D1.0~D1.3, D2.0~D2.3, D3.0~D3.3, D4.0~D4.3
Pulse width range	8ns ~ 10s

Video trigger

Signal standard	NTSC, PAL, HDTV720P, HDTV1080P, HDTV1080i
data source	CH1~CH4
Synchronize	Scan line, line number, odd field, even field, all fields

Scope trigger

Scope	Rising, falling
Condition	<, >, !=, =
Data source	CH1~CH4
Time range	8ns ~ 10s

Overtime trigger

Data source	CH1~CH4,
-------------	----------

	D1.0~D1.3, D2.0~D2.3, D3.0~D3.3, D4.0~D4.3
Polarity	Positive, Negative
Time range	8ns~10s
Window trigger	
Data source	CH1~CH4
Pattern trigger	
Pattern	0: low level; 1: high level; X; ignore;
Level (data source)	CH1~CH4 D1.0~D1.3, D2.0~D2.3, D3.0~D3.3, D4.0~D4.3
Interval trigger	
Slope	Rising, falling
Condition	<, >, !=, =
Data source	CH1~CH4, D1.0~D1.3 D2.0~D2.3, D3.0~D3.3, D4.0~D4.3
Time range	8ns~10s
Delay trigger	
Edge type	Rising, falling
Data source	CH1~CH4, D1.0~D1.3 D2.0~D2.3, D3.0~D3.3, D4.0~D4.3
Condition	<, >, !=, =
Time range	8ns~10s
Setup/hold trigger	
Edge type	Rising, falling
Data source	CH1~CH4, D1.0~D1.3 D2.0~D2.3, D3.0~D3.3, D4.0~D4.3
Time range	8ns~10s
Under Amp trigger	
Polarity	Positive, Negative

Condition	<, >, !=, =
Data source	CH1~CH4
Time range	8ns~10s
UART trigger	
Condition	Start, stop, data, parity, receive error
Data source (RX/TX)	CH1~CH4, D1.0~D1.3 D2.0~D2.3, D3.0~D3.3, D4.0~D4.3
Data format	Hex
Data length	1 byte
Data bits	5 bit, 6 bit, 7 bit, 8 bit
Parity	None, Odd, Even
Idle level	high, low
Baud rate (optional)	110/300/600/1200/2400/4800/9600/14400/19200/38400/57600/115200/230400/380400/460400 bit/s
Baud rate (custom)	300bit/s~334000bit/s
LIN trigger	
Condition	Interval field, sync field, ID field, sync error, identifier, ID, and data
Data source	CH1~CH4, D1.0~D1.3 D2.0~D2.3, D3.0~D3.3, D4.0~D4.3
Data format	Hex
Baud rate (optional)	110/300/600/1200/2400/4800/9600/14400/19200/38400/57600/115200/230400/380400/460400 bit/s
Baud rate (custom)	300bit/s~334000bit/s
CAN trigger	
Condition	Start bit, remote frame ID, data frame ID, frame ID, data frame data, error frame, all errors, response error, overload frame
Data source	CH1~CH4, D1.0~D1.3 D2.0~D2.3, D3.0~D3.3, D4.0~D4.3
Data format	Hex
Baud rate (optional)	10000, 20000, 33300, 500000, 62500, 83300, 100000, 125000, 250000, 500000, 800000, 1000000
Baud rate (custom)	5kbit/s~1Mbit/s
SPI trigger	
Data source	CH1~CH4,

	D1.0~D1.3 D2.0~D2.3, D3.0~D3.3, D4.0~D4.3
Data format	Hex
Data bits	4 bit, 8 bit, 16 bit, 24 bit
IIC trigger	
Data source (SDA/SCL)	CH1~CH4, D1.0~D1.3 D2.0~D2.3, D3.0~D3.3, D4.0~D4.3
Data format	Hex
Data index	0~7
Condition	Start bit, stop bit, no response, address, address and data, restart

Measurement

Cursor	voltage difference between cursors ΔV Time difference between cursors ΔT ΔT reciprocal in Hz ($1/\Delta T$)	
Automatic measurement	Frequency, period, average, peak-peak, root mean square, minimum, maximum, rise time, fall time, positive pulse width, negative pulse width, bottom value, top value, middle value, amplitude, Overshoot, preshoot, positive duty cycle, negative duty cycle, cycle average, cycle root mean square, falling edge overshoot, rising edge preshoot, BWidth, FRF, FFR, LRR, LRF, LFR, LFF, FRR, FFF, maximum time, minimum time, positive phase difference, negative phase difference, variance, positive pulse number, negative pulse number, rising edge number, falling edge number, trigger count	
DVM	data source	CH1, CH2, CH3, CH4
	Measurement type	DC rms AC effective value DC
	Frequency meter	Hardware 6-bit frequency meter

Display

Display Type	7 "TFT LCD Diagonal
Display resolution	800 (horizontal) * 480 (vertical) pixels
Display color	16 million colors (24 bit true color)
Persist time	Min, 1 s, 5 s, 10 s, 30s, infinite
Display type	Point, vector
Display mode	Color grade
Display brightness	Adjustable
Grid Type	Optional

Grid brightness	Adjustable
Waveform brightness	Adjustable

Interface

Standard interface	USB Host, USB Device, LAN, WIFI (EDU model) Aux trigger output / pass failure (MPO6000EDU model)
Optional interface	Aux trigger output / pass failure UART HDMI

Arbitrary signal generator (with signal source series)

Number of channels	2/3 channels Arb1, Arb2, Arb3, Arb4	
Sampling rate	200MSa/s	
Vertical resolution	12 bits	
Frequency	25 MHz	
Standard waveform	sine wave, square wave, pulse, triangle wave, noise, DC, Sinc, Exp, Haver Sine, Lorentz, dual tone multi-frequency, Gauss, ECG signal	
Arbitrary waveform	Arb1, Arb2, Arb3, Arb4	
Frequency characteristics		
Sine wave	1uHz~25MHz	
Square wave	1uHz~15MHz	
Pulse	1uHz~5MHz	
Triangle wave	1uHz~1MHz	
Noise		
Sinc	1uHz~5MHz	
Exp	1uHz~5MHz	
Haver Sine	1uHz~5MHz	
Lorentz	1uHz ~5MHz	
dual tone multi-frequency	1uHz ~5MHz	
Gauss	1uHz ~5MHz	
ECG	1uHz ~5MHz	
Arbitrary wave		
Wave	Length	8KSa
Frequency	Range	1uHz~75MHz
	Accuracy	(less than 10 kHz) 50 ppm (more than 10 kHz)
	Resolution	0.1 Hz or 4 bits, whichever is greater
Amplitude	Output range	10mV~7Vpp (high impedance) 5mV~3.5Vpp(50Ω)
DC offset	Range	±7 V, high impedance

		$\pm 3.5\text{ V}$, $50\ \Omega$
	Resolution	100 μV or 3 bits, whichever is greater
	Accuracy	2% (1 kHz)
Output impedance	50 Ω , high impedance	

General technical specifications

Probe compensator output		
Output voltage, typical	2Vpp input $\geq 1\text{M}\Omega$ load	
Frequency, typical	1kHz	
power supply		
Power supply voltage	100-120VACRMS ($\pm 10\%$), 45Hz to 440Hz, CAT II 120-240VACRMS ($\pm 10\%$), 45Hz to 66Hz, CAT II	
Power consumption	less than 30W	
Fuse	T, 3.15A, 250V, 5x20mm	
Surroundings		
Operating temperature	0~50 $^{\circ}\text{C}$ (32~122 $^{\circ}\text{F}$)	
Storage temperature	-40~+71 $^{\circ}\text{C}$ (-40~159.8 $^{\circ}\text{F}$)	
Humidity	$\leq + 104\ ^{\circ}\text{F}$ ($\leq + 40\ ^{\circ}\text{C}$): $\leq 90\%$ relative humidity	
	106 $^{\circ}\text{F}$ ~ 122 $^{\circ}\text{F}$ (+ 41 $^{\circ}\text{C}$ ~ 50 $^{\circ}\text{C}$): $\leq 60\%$ relative humidity	
Cooling method	Convection	
Altitude	with and without operation	3000m (10,000 feet)
	Random vibration	0.31 g RMS from 50Hz to 500Hz, 10 minutes per axis
Mechanical shock	when not operating	2.46g RMS from 5Hz to 500Hz, 10 minutes per axis
	during operation	50g, 11ms, half sine wave
Mechanical part		
Oscilloscope size	318 x 140 x 150mm (length x width x height)	
Weight	2900g	

Appendix

Appendix A:

Accessories

The following accessories are provided with this product. All accessories can be obtained by contacting your local supplier.

Standard accessories:

Four passive voltage probes (X1, X10)

- One power cord
- One USB cable
- One LAN cable
- BNC to BNC cable

Note: DPO6000B series and DPO6000EDU series do not have BNC line; DPO6000C series and MPO6000D series have 2 BNC lines; MPO6000EDU series have 3 BNC lines.

- A software CD
- Warranty card
- Product certificate
- Calibration certificate

Appendix B:

Hazardous substances or elements contained in the product

Part Name 2	Toxic or harmful substances or elements 1					
	Pb	Hg	Cd	Cr(Vi)	PBB	PBDE
Product shell, chassis	X	0	0	X	0	0
Display module	X	X	0	0	0	0
Circuit board components	X	0	0	X	0	0
Power components	X	0	0	X	0	0
Wire and cable assembly	X	0	0	0	0	0
Connector	X	0	0	X	0	0
Fasteners and mounting hardware	X	0	X	X	0	0
other attachments (Including probe)	X	0	0	X	0	0
other	0	0	0	0	0	0

"X" indicates that the content of the toxic and hazardous substance in at least one homogeneous material of the part exceeds the limit requirement specified in the SJ / T 11363-2006 standard.

"0" indicates that the content of the toxic and harmful substance in all homogeneous materials of the part is below the limit requirement specified in the SJ / T 11363-2006 standard.

The list of part names includes the components allowed in the Administrative Measures.